

COBALT



C-2500 & C-3000 Fully Featured FM Transmitter Installation Guide and User Manual Version 1.16



Creating the Most Exciting and Engaging FM Broadcast experience possible...

We're grateful that you have chosen an Aqua Broadcast FM Transmitter. We hope that you enjoy your Aqua Broadcast product for many years to come.

Everyone here at Aqua Broadcast is passionate about developing new and innovative products. By shaping the future of FM Broadcast by delivering innovative, intuitive solutions that inspire our customers to create the most exciting and engaging content possible.

From everyone at Aqua Broadcast, thanks for your purchase.

ABOUT COBALT

The COBALT Series of FM Transmitters has been designed with future Broadcast in mind. Utilizing the latest DDS (Direct to Digital Synthesis) Modulation, giving you the cleanest and most stable signal out there.

This user manual covers the entire COBALT range, the user settings and controls are the same regardless of the power, so if you can use one you can use them all!

All COBALT Transmitters have the following standard features,

- ~ DDS FM Exciter
- ~ Dynamic, UECP RDS Encoder
- ~ Digital MPX with
- ~ GPS Sync
- ~ ITU-R BS412.9 Limiter
- ~ 4 Band Audio Processor
- ~ Linux OS
- ~ RGB Screen
- ~ Ethernet Control
- ~ SNMP

User Warnings and Cautions	5
Safety Information	6
Operating Environment	6
Installation	6
Operation	7
Repair and Service	7
Detailed Safety Instructions	8
Product Disposal and Hazards	9
Warranty	10
Wiring	11
Front and Rear Images	13
Pinouts	14
User Input Experience	15
Home Screen	16
LED status meanings on the front panel	17
Inputs Screen	18
Audio Processor	19
Audio Processor Presets	20 & 21
RDS	22
Exciter and Stereo Encoder	23
Outputs	25
System and Network	26
Web Interface	27
Dashboard	28
Radio Frequency Screen	29
µMPX Screen (optional)	30
Inputs Screen	31
Audio Processor Screen	32
RDS Screen	33
Exciter and Stereo Screen	35

Outputs Screen and Audio Monitoring	37
SFN Sync Screen	38
Tuner Screen (optional)	39
Audio Manager	45
Automations	47
Configs	48
Modulation Failover	49
RF Off on Silence	50
Scheduler	51
Notifications	
Faults	52
Alarms	53
GPI Setup	54
GPO Setup	55
Automations	56
User	57
System Screen	
Services	58
Unit	59
Network	60
Emails	60
User Management	61
Logs	62
Diagnostics	63
RS232 & Telnet application notes	64
Specifications	66
Certifications	68
Contact Information	69

The installation and service instructions in this manual are for use by qualified personnel only. To avoid electric shock, do not perform any servicing other than that contained in the operating instructions unless you are qualified to do so.

Refer all servicing to qualified personnel

This product has an auto-ranging line voltage input. Ensure the power voltage is within the specified range stated on the rear of the unit.

CAUTION: HAZARDOUS VOLTAGES

This paragraph concerns safety instruction related to all Aqua Broadcast Transmitter products in general.

Aqua Broadcast makes every effort to keep the safety standards of our products up to date and to offer our customers the highest possible degree of safety. Our products and the auxiliary equipment they require are designed, built and tested in accordance with the safety standards that apply in each case. Compliance with these standards is continuously monitored by our quality assurance system.

Aqua Broadcast products are compliant with safety rules for broadcasting transmitter as defined by IEC / EN 60215 and its amendment. According to this standard only skilled person are allowed to operate on Aqua Broadcast devices IEC / EN 60215 and its amendment defines the minimum requirements for skilled electrical personnel.

The compliance with this standard is a pre-condition for operating with Radio Broadcasting equipment. The operator or the operator's authorized representative is responsible for ensuring compliance with these guidelines. They are also responsible to achieve necessary authorization by site owner or according to local laws to operate hereunder. They must also ensure that the operating personnel meets the applicable country-specific training requirements. These requirements also may include any periodic training that is necessary.

The products described here have been designed, manufactured and tested according the relevant standards and directive, see EC/ EU declaration of conformity attached to this manual. The products described here have left the manufacturers facilities fully compliant with safety standards. To maintain this condition and to ensure safe operation, you must observe all instructions and warnings provided in this manual. For any clarification on it, for any doubt or any suggestion please directly contact Aqua Broadcast at support@aquabroadcast.co.uk

Furthermore it is your responsibility to operate the device in an appropriate manner. This product is designed to work in telecommunications centres only, except when expressly authorized, and must not be used in any way that may cause injury to persons or goods. In case the product is used for any intention other than its designated purpose or in disregard of its instructions you, the operator, are the sole responsible for any damage that this un-proper operation may cause.

The product is used properly when it is used in accordance with its instructions and under its operating conditions and its performance limits (refer to product manual, modules, manuals and products or modules datasheets). This condition may only be assumed by a skilled person with a basic knowledge of English (since all symbols, labels and message displayed are referred to in this language).

Skilled people also have to check if particular requirements or special equipment or tools are required depending on the product or the environment and to follow all instructions to use any additional special equipment.

The Product manual, and in particular safety instructions should be kept near the product in a safe place, in order to be available for all skilled personnel who operate the device. Observing the safety instructions will help prevent personal injury or damage to goods caused by dangerous situations. Therefore, carefully read through and adhere to the following safety instructions before and when using the product. It is also absolutely essential to observe the additional safety instructions on personal safety, for example, that appear in relevant parts of the product documentation or that are given on the operating site.



CHECK ALL ELECTRICAL CONNECTIONS ARE CORRECT AND SAFE BEFORE POWERING ON THE TRANSMITTER

The product may be operated only under the operating conditions and in the positions specified by the manufacturer, without any obstruction in product's ventilation. If the manufacturer's specifications are not observed, this can result in electric shock, fire and/or serious personal injury or death. Applicable local or national safety regulations and rules for the prevention of accidents must be observed in all cases. Unless otherwise specified, the following environmental requirements apply to Aqua Broadcast products: Use only indoors, the maximum operating altitude 3000 m above sea level, maximum transport altitude 6000 m above sea level. A tolerance of $\pm 15\%$ shall apply to the nominal voltage and $\pm 5\%$ to the nominal frequency. Do not place the product on surfaces, cabinets, or tables that for reasons of weight or stability are unsuitable for this purpose.

Always follow the manufacturer's installation instructions when installing the product and fastening it to objects or structures (e.g. walls and shelves). An installation that is not carried out as described in the product documentation could result in personal injury or death. Do not place the product on heat-generating devices such as radiators or fan heaters. The ambient temperature must not exceed the maximum temperature specified in the product documentation or in the data sheet. Product overheating can cause electric shock, fire and/or serious personal injury or death. Do not install, operate, maintain the device if you are physically or mentally stressed.

INSTALLATION

If the information on electrical safety is not observed there is a possibility that electric shock, fire and/or serious personal injury or death may occur.

Prior to switching on the product, always ensure that the product nominal voltage setting matches with the nominal voltage of the AC supply network. If there is a mismatch do not connect the product to the power network until the mismatch is resolved. If a different voltage is to be set, the power fuse of the product may have to be changed accordingly.

In the case of products of safety Class 1 with a removable power cord and connector, operation is permitted only on sockets with an earth contact and protective earth connection.

Intentionally breaking the protective earth connection either in the feed line or in the product itself is not permitted. Doing so can result in the danger of an electric shock from the product. If extension cords or connector strips are implemented, they must be checked on a regular basis to ensure that they are safe to use.

If the product does not have a power switch for disconnection from the AC supply network, the plug of the connecting cable must be considered as the disconnecting device. In this case, always ensure that the power plug is always easily reachable and accessible. Ensure also that the plug-in connection is secure, bad connections may cause damage to the equipment and may be unsafe. Functional or electronic switches are not suitable for providing disconnection from the AC supply network. If products without power switches are integrated into racks or systems, a disconnecting device must be provided at the system level in site main electrical switchboard.

Never use the product if the power cable is damaged. Check the power cable on a regular basis to ensure that it is in proper operating condition. Check the power cable is suitable for the power ratings of the device by taking appropriate safety measures and carefully laying the power cable, you must ensure that the cable will not be damaged and that no one can be hurt by tripping over the cable or suffering an electric shock.

The product may be operated only from TN/TT supply networks.

Do not insert the plug into sockets that are dusty or dirty. Insert the plug firmly and all the way into the socket. Otherwise, sparks could result in fire and/or injuries may occur.

For measurements in circuits with voltages $V_{rms} > 30\text{ V}$, suitable precautions (e.g. appropriate measuring equipment, fusing, current limiting, electrical separation, insulation) should be taken to avoid any hazards.

Ensure that the connections with information technology equipment, e.g. PCs or other industrial computers, comply with the IEC60950-1/EN60950-1 or IEC61010-1/EN 61010-1 standards that apply in each case.

Unless expressly permitted, never remove the cover or any part of the housing while the product is in operation. Doing so will expose circuits and components and can lead to injuries, electrical shock, fire, or damage to the product.

Aqua Broadcast products are designed to be permanently installed, so the connection between the PE terminal on site and the product's PE conductor must be made first before any other connection is made.

Permanently installed equipment must have either built-in fuses, circuit breakers or similar protective devices, moreover the supply circuit must be fused in such a way that anyone who has access to the product, as well as the product itself, is adequately protected from injury or damage.

Use suitable over-voltage protection to ensure that no over-voltage (such as that caused by a bolt of lightning) can reach the product. Otherwise, the person operating the product will be exposed to the danger of an electric shock. Products are normally designed to operate in an indoor environment (IP 20 typically) no liquid protection is therefore given, the equipment must be protected from all liquids. If the necessary precautions are not taken, the user may suffer electric shock or the product itself may be damaged, which can also lead to personal injury.

Never use the product under conditions in which condensation has formed or can form in or on the product, e.g., if the product has been moved from a cold to a warm environment. Penetration by water increases the risk of electric shock.

Prior to cleaning the product, disconnect it completely from the power supply (e.g., AC supply network or battery). Use a soft, non-lining cloth to clean the product. Never use chemical aggressive cleaning agents such as alcohol, acid, acetone, or diluents for cellulose lacquers.

OPERATION

Operating the equipment requires trained and skilled personnel. It requires also intense concentration. Make sure that people who operates is physically, intellectually, and mentally fit to do so. Physical or mental stress may cause a fall in concentration, and this may cause injury or material damage.

Before you install, connect, operate, disconnect, or dismount the equipment, read the relative safety instructions. In case of fire, some hazardous substances may be released by the unit, such as gas or fluids. This can cause health problems. So, in this case necessary measures must be taken, such as protective masks, gloves, clothing and so on should be used.

REPAIR AND SERVICE

Special training is required to open and repair Aqua Broadcast devices. Before removing the lid and before opening it, the AC mains must be switched off and disconnected and then wait at least 30 seconds for the discharge of energy of any capacitors. Otherwise, there could be a risk of electrical shock.

It is strongly recommended to send faulty devices / modules to the factory for repair, if feasible. Otherwise only when authorized by Aqua Broadcast, trained personnel may perform repairs. All repairs require only original spare parts to be used. After repair a safety test is recommended (visual inspection, electrical test, insulation test, ground continuity test, leakage current measurement, functional test and so on) This helps to assure the continued safety of the device.

If products or their components are mechanically and/or thermally processed in a manner that goes beyond their intended use, hazardous substances (heavy-metal dust such as lead, beryllium, nickel) may be released. For this reason, the product may only be disassembled by specially trained personnel. Improper disassembly may be hazardous to your health. National waste disposal regulations must be observed. The improper disposal of hazardous substances or fuels can cause health problems and lead to environmental damage.

All the safety and operation instructions should be read before the unit is operated.

- Retain Instructions:** The safety and operating instructions should be retained for future reference.
All warnings on the unit and in the operating instructions should be adhered to.
- Follow instructions:** All operation and user instructions should be followed.
- Water and Moisture:** The unit should not be used near water. The unit should not be exposed to dripping or splashing and objects filled with liquids should not be placed on or within close proximity of the Transmitter.
- Ventilation:** The unit should be situated so that its location or position does not interfere with its proper ventilation. For example, the unit should not be situated on a surface that may block the ventilation openings, or placed in a built-in installation, such as a bookcase or cabinet that may impede the flow of air through the ventilation openings.
- Grounding or Polarisation:** Precautions should be taken so that the grounding or polarisation method of the unit is not defeated or compromised.
- Power-Cord Protection:** Power supply cords should be routed so that they are not likely to be walked on or pinched by items placed upon or against them, paying particular attention to cords and plugs, convenience receptacles and the point where they exit from the unit.
- Cleaning:** The unit should be cleaned only as recommended by the manufacturer. Wash your hands after any cleaning.
- Non-use Periods:** The power cord of the unit should be unplugged from the outlet when left unused for a long period of time.
- Object and Liquid Entry:** Care should be taken so that objects do not fall and liquids are not spilled into the enclosure through openings.
- Damage Requiring Service:** The unit should be checked and serviced by qualified service personnel when:
 - The power supply cord or the plug has been damaged
 - Objects have fallen, or liquid has been spilled into the appliance
 - The appliance has been exposed to rain
 - The appliance does not appear to operate normally or exhibits a marked change in performance
 - The appliance has been dropped, or the enclosure damaged

During product disposal the following directives must be adhered to:

- 2002/96/EC on waste electrical and electronic equipment (WEEE),
- 2002/95/EC on the restriction of the use of certain hazardous substances in electrical and electronic equipment (RoHS).



Once a product is at the end of its lifetime, the product must not to be disposed of in standard domestic civil refuse. Even disposal of on municipal collection points for waste electrical electronic device is not allowed. It has to be treated as electronic waste.

Hazards due to Beryllium Oxide / Beryllium Copper (BeO)

In case the apparatus contains components are using Beryllium Oxide / Beryllium Copper, these shall be labelled with special symbols.

- **DANGER!** Beryllium Oxide / Beryllium Copper is dangerous when inhaled, ingested or in contact with the skin, especially if cut or scratched. After handling products containing Beryllium Oxide / Beryllium Copper, wash your hands immediately.
- If handled correctly, parts or components containing Beryllium Oxide / Beryllium Copper are not hazardous to health. If used improperly, however, Beryllium Oxide / Beryllium Copper dust may be released. Beryllium Oxide / Beryllium Copper dust causes chronic disease (berylliosis); inhaling large amounts over an extended period of time is toxic, causing respiratory paralysis and death.

Rules for Handling Beryllium Oxide / Beryllium Copper:

- Parts or components containing Beryllium Oxide / Beryllium Copper ceramics must not be opened, mechanically processed, or destroyed.
- Above all, these parts or components must not be scratched, broken, ground, tempered and sandblasted, not even under exhaust hoods.
- In the transmitter, all components containing parts made from Beryllium Oxide / Beryllium Copper are marked with a warning symbols and a labels.



Please ensure the warranty registration process is completed upon receipt of this product.

To do so, go to www.aquabroadcast.co.uk/support with your product's serial number to hand. Aqua Broadcast warrants the mechanical and electronic components of this product to be free of defects in material and workmanship for a period of up to Two years from the original date of purchase, in accordance with the warranty regulations described below. If the product shows any defects within the specified limited warranty period that are not due to normal wear and tear and/or improper handling by the user, Aqua Broadcast shall, at its sole discretion, either repair or replace the product. If the warranty claim proves to be justified, the product will be returned to the user. The return freight for any Warranty repair or claim will be paid by Aqua Broadcast during the 2-year Warranty, thereafter freight will be the responsibility of the customer. Warranty claims other than those indicated above are expressly excluded.

NOTE: The warranty registration process must be carried out as described above to enable warranty cover.

Return authorisation number: To obtain warranty service, the buyer (or his authorised dealer) must contact Aqua Broadcast during normal business hours BEFORE returning the product. All inquiries must be accompanied by a description of the problem. Aqua Broadcast will then issue a return authorisation number. Subsequently, the product must be returned in its original shipping carton, together with the return authorisation number to the address indicated by Aqua Broadcast.

Warranty regulations: Any product deemed eligible for repair or replacement by Aqua Broadcast under the terms of this warranty will be repaired or replaced within 30 days of receipt of the product at Aqua Broadcast. If the product needs to be modified or adapted to comply with applicable technical or safety standards on a national or local level, in any country which is not the country for which the product was originally developed and manufactured, this modification/adaptation shall not be considered a defect in materials or workmanship. The warranty does not cover any such modification/adaptation, irrespective of whether it was carried out properly or not. Under the terms of this warranty, Aqua Broadcast shall not be held responsible for any cost resulting from such a modification/adaptation. Free inspections and maintenance/repair work are expressly excluded from this warranty if caused by improper handling of the product by the user. This also applies to defects caused by normal wear and tear of potentiometers, keys/buttons, and similar parts. Damages/defects caused by the following conditions are not covered by this warranty: Misuse, neglect, or failure to operate the unit in compliance with the instructions given in Aqua Broadcast user or service manuals. Connection or operation of the unit in any way that does not comply with the technical or safety regulations applicable in the country where the product is used. Damages/defects caused by force majeure or any other condition that is beyond the control of Aqua Broadcast. Any repair or opening of the unit carried out by unauthorized personnel (user included) will void the warranty. If an inspection of the product by Aqua Broadcast shows that the defect in question is not covered by the warranty, the inspection costs are payable by the customer. Products that do not meet the terms of this warranty will be repaired exclusively at the buyer's expense. Aqua Broadcast will inform the buyer of any such circumstance.

Warranty transferability: This warranty is extended exclusively to the original buyer (customer of the retail dealer) and is not transferable to anyone who may subsequently purchase this product. No other person (retail dealer, etc.) shall be entitled to give any warranty promises on behalf of Aqua Broadcast.

Claims for damages: Failure of Aqua Broadcast to provide proper warranty service shall not entitle the buyer to claim (consequential) damages. In no event shall the liability of Aqua Broadcast exceed the invoiced value of the product.

Other warranty rights and national law: This warranty does not exclude or limit the buyer's statutory rights provided by national law any such rights against the seller that arise from a legally effective purchase contract. The warranty regulations mentioned herein are applicable unless they constitute an infringement of national warranty law.



CHECK ALL ELECTRICAL CONNECTIONS ARE CORRECT AND SAFE BEFORE POWERING ON THE TRANSMITTER

The C-2500 and C-3000 Transmitters need to be wired up correctly and safely. It is recommended that connections are made by a suitably qualified and licensed electrician.

Both models can be powered up either by a Single, or a 3 Phase connection. Please select the method that best suits your facility.

THREE PHASE CONNECTION

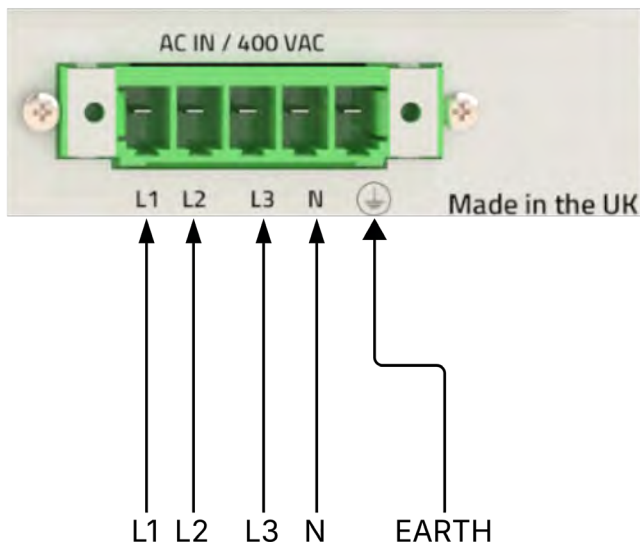

It is important to note that Wiring colours do vary between countries. Below is an example of some colours used, but please be sure that you comply with your local regulations.

Region	Earth (E)	Neutral (N)	Line 1 (L1)	Line 2 (L2)	Line 3 (L3)
Europe & UK	Green	Blue	Brown	Black	Grey
UK (Old)	Green	Black	Red	Yellow	Blue
Australia	Green	Black	Red	White	Blue
USA	Green	White	Black	Red	Blue

SINGLE PHASE CONNECTION

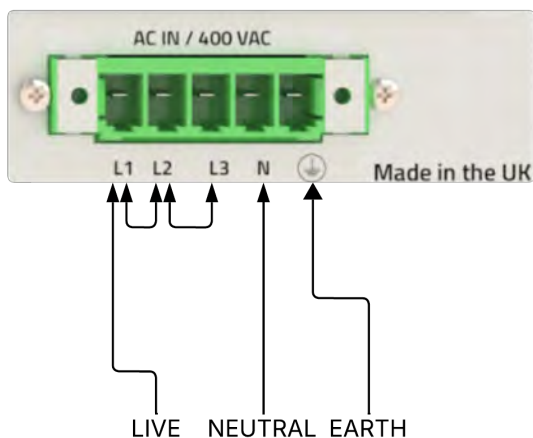

Region	Earth (E)	Neutral (N)	Line 1 (L1)
Europe & UK	Green	Blue	Brown
UK (Old)	Green	Black	Red
Australia	Green	Black	Red
USA	Green	White	Black

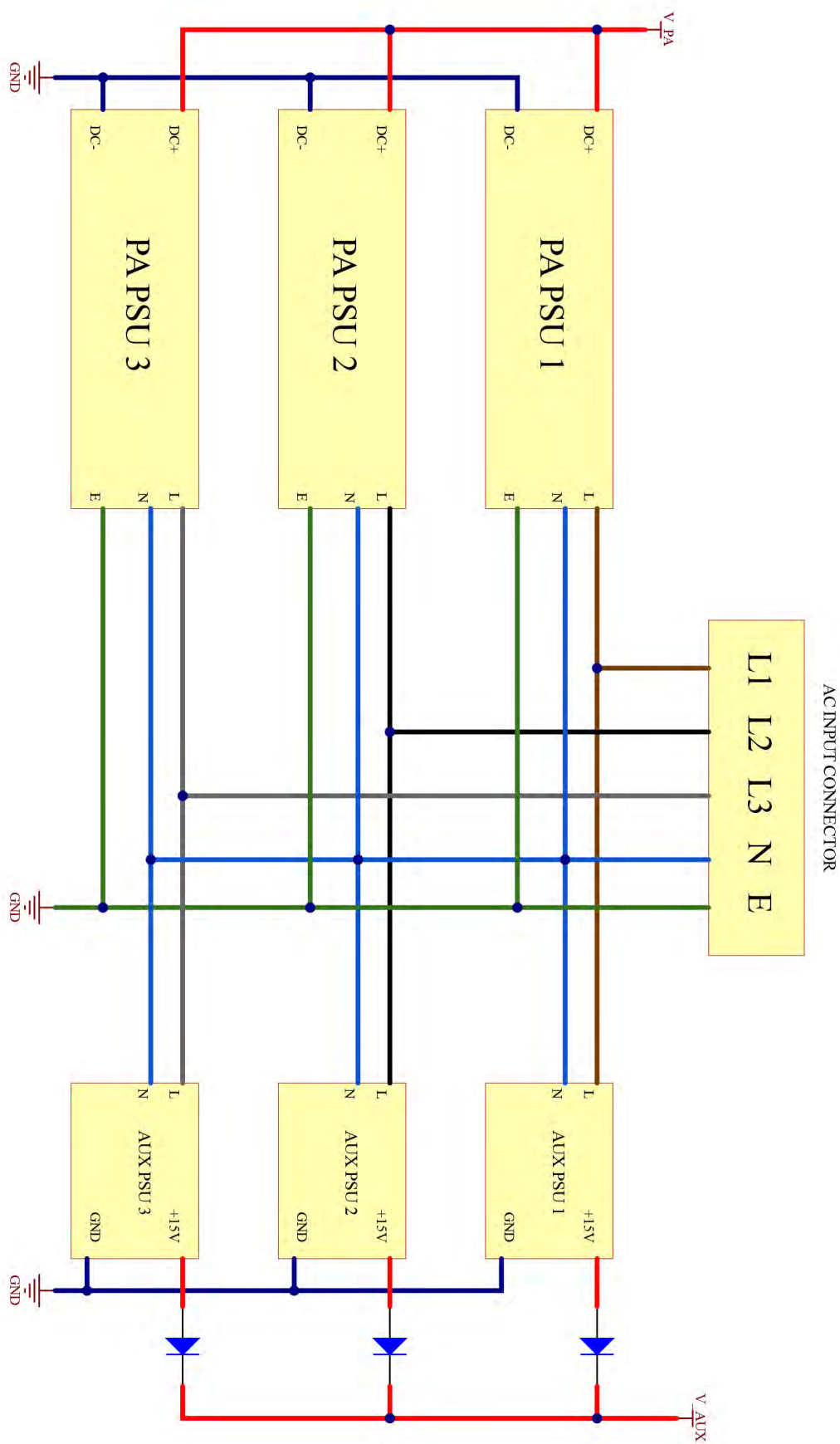

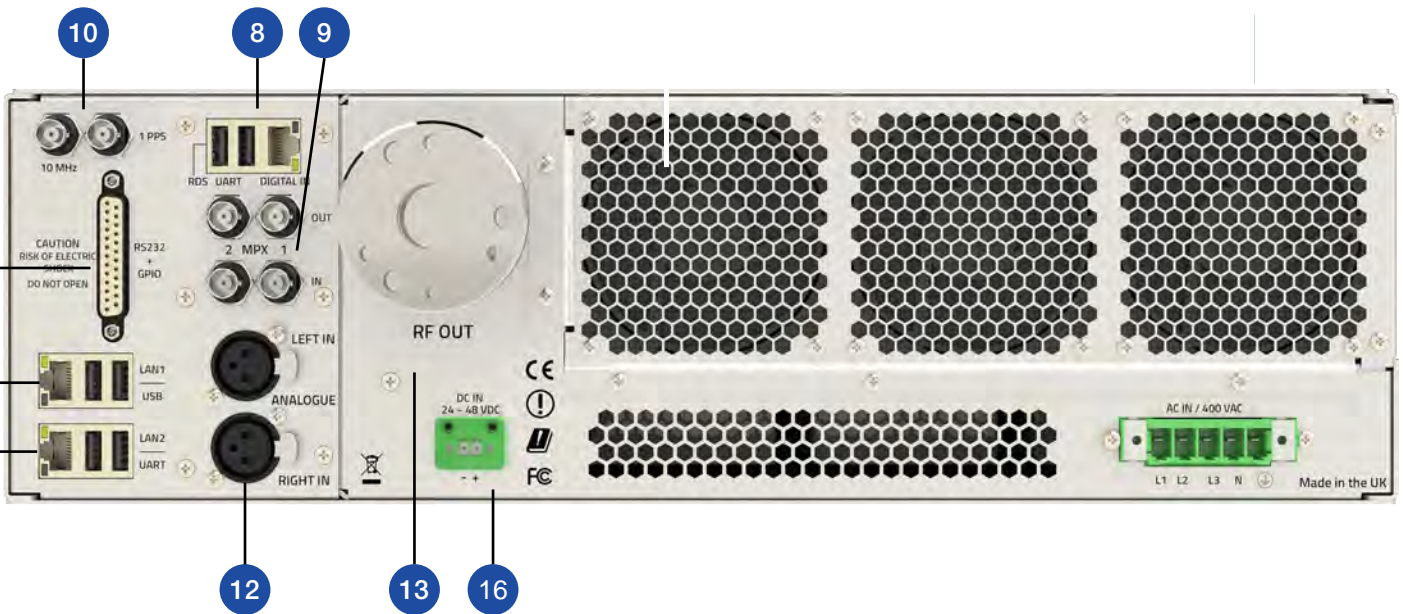
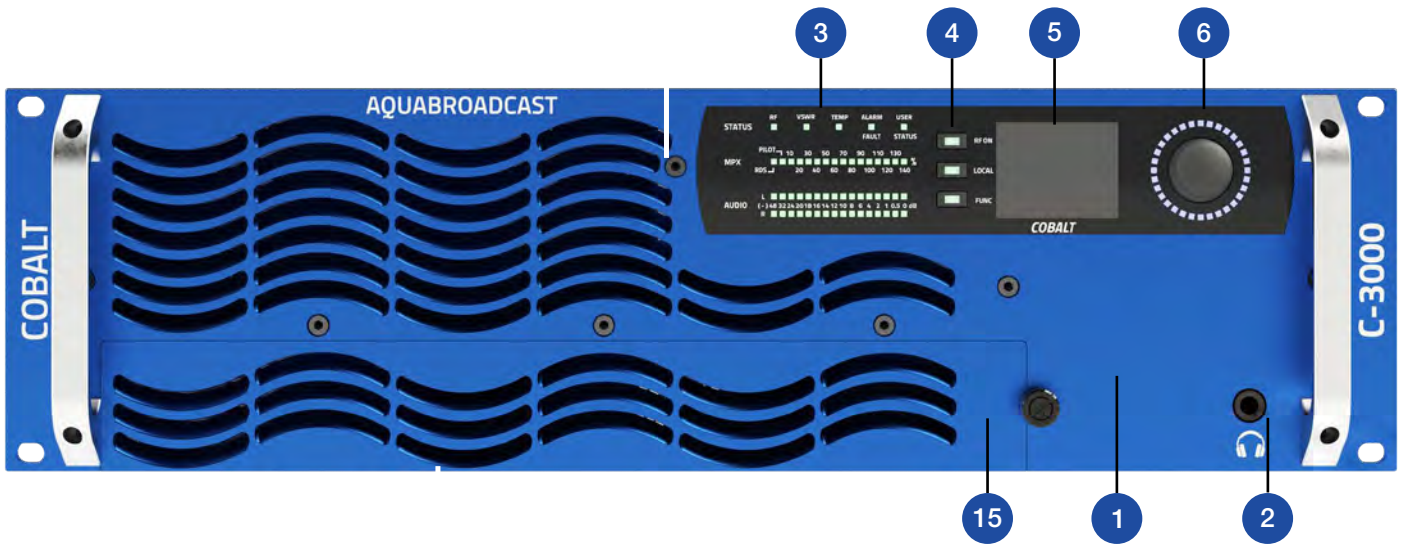

- 1. RF Monitor Port
- 2. Headphones
- 3. Meters
- 4. Quick Buttons
- 5. RGB Screen
- 6. Joystick

- 7. LAN 1 and USB
- 8. Digital Audio In and RDS Data
- 9. MPX 1 & 2 Inputs and Outputs
- 10. GPS Sync Inputs
- 11. RS232 and GPIOD
- 12. Analogue Inputs

- 13. RF Out
- 14. LAN 2 / UART
- 15. Power supplies
- 16. Optional 24/48V DC Input

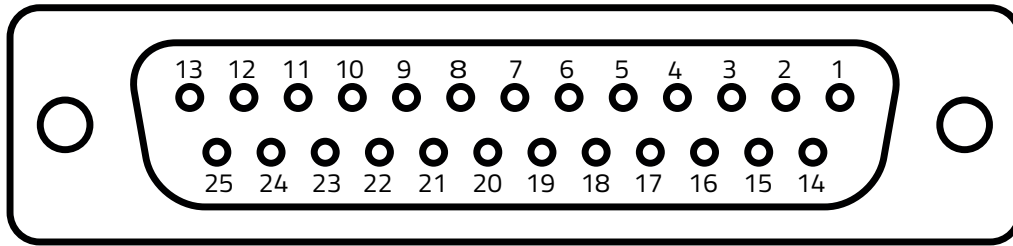

D-SUB 25 FEMALE CONNECTOR

PIN NUMBER	SIGNAL COMMAND
1	GP OUT
2	GP OUT
3	GP OUT
4	GP OUT
5	GP IN
6	GP IN
7	GP IN
8	GP IN
9	ANALOG OUT (330Ohm, 0-5 V)
10	ANALOG OUT (330Ohm, 0-5 V)
11	UART (RS232 CONVERTER)
12	5V (SPARE POWER) 250mA
13	INTERLOCK
14	GP OUT
15	GP OUT
16	GP OUT
17	GP OUT
18	GP IN
19	GP IN
20	GP IN
21	GP IN
22	ANALOG OUT (330 Ohm, 0-5 V)
23	ANALOG OUT (330 Ohm, 0-5 V)
24	UART (RS232 CONVERTER)
25	GND

The Cobalt series features a click-able joystick as the main input interface so you can move and click with just one hand. The incorporated haptics compliment the visual information with tactile feedback for a complete experience. The analogue capabilities of the joystick are put to good use during parameter editing, where you can tilt the joystick further to accelerate value changes. Change the values more slowly by tilting the joystick less or just tap it shortly for precise small step value changes.

The navigation through the menus occurs at two levels.

- On the first level you can quickly browse through the different screens:

The main menu categories are connected as a ring, on the left/right direction, but there might be related screens hanging up or down. On each screen, BLUE labels on its sides show the available navigation directions.

- On the second level you can navigate inside a particular screen:

Once you have reached the screen where the parameter you want to change is, hit the button once to enter that screen. You can now move through the parameters in that page.

Move to that parameter and click to start editing that parameter. Use the joystick to change the value and then click to accept or double click to cancel (revert to the previous value). Double click again to go back to screen navigation.

When editing a parameter, the LED ring shows the value of the parameter with respect to the parameter range.

Enter and exit menu navigation

- ~ To select one screen: click
- ~ To resume screen navigation: double click.



Enter and exit menu navigation

- ~ Move through the menus until reaching the relevant screen.
- ~ Press the joystick once to enter that category.
- ~ Use the joystick to navigate to the desired parameter
- ~ Click once to start editing the selected parameter.
- ~ Move the joystick to edit the parameter value/option. Tilt the joystick further to change the value faster.
- ~ If you want to save the new value, click the joystick. Double click will revert the value to the previous one. This will also deselect the parameter and also exit the parameter editing mode.
- ~ Double click to deselect the parameter and return to navigation inside the screen.
- ~ Double click to exit to menu navigation.

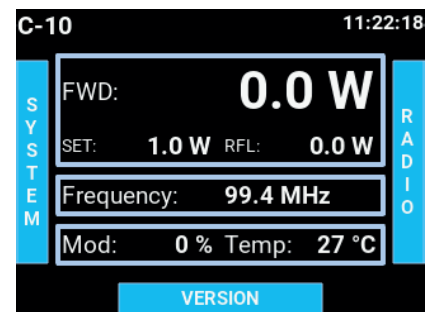

Soft Buttons

- RF ON RF ON/OFF button
- LOCAL Sets the unit in LOCAL or REMOTE mode
- FUNC Mutes the headphones



THE FRONT PANEL RF ON BUTTON NEEDS TO BE PRESSED FOR ONE SECOND FOR IT TO BE ACTIVATED OR DE-ACTIVATED

The Home screen on the front of all Cobalt products is equivalent to the dashboard used in the web-remote, showing the most important details on the units' operation.

The top row shows

- ~ Model name
- ~ System Time

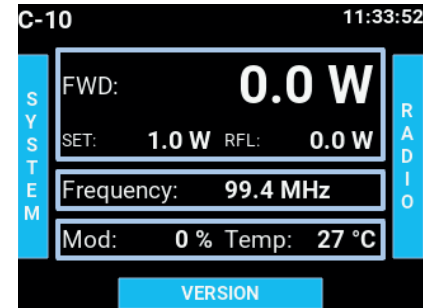

The screen also shows RF power, Frequency, Modulation and PA Temperature

- ~ **FWD:** Shows forward power read from the PA. Press the joystick once to enter that category.
- ~ **SET:** Shows power setting from the Radio menu.
- ~ **RFL:** Shows reflected power reading.
- ~ **Frequency:** Shows frequency setting
- ~ **Mod:** Shows the modulation level in %
- ~ **Temp:** Shows the Transmitter temperature read from the PA.

RADIO SCREEN

The Radio screen on the front of all Cobalt products allows for changes and setting of Radio parameters such as Power, Frequency, and Enable (RF On/Off).

The Radio screen shows all the RF current settings

- ~ **FWD:** Shows the actual forward power reading.
- ~ **RFL:** Shows the actual reflected power reading.
- ~ **VSWR:** Shows the actual calculated VSWR value reading.
- ~ **PA Temp:** Shows the current Transmitter Temperature reading
- ~ **RF Enable:** ON or OFF enables or disables the RF.
- ~ **Set power:** Sets the RF power in Watts that you require.
- ~ **Frequency:** Sets the Frequency you require

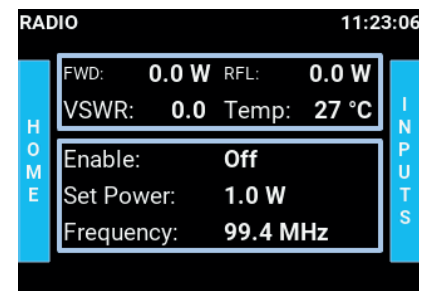





The RFL, VSWR and PA Temp have associated thresholds for protection. When the threshold is reached (excessive RFL or VSWR or too high temperature) the Cobalt protection measures will proportionally decrease the RF power produced to keep the values at safe levels. If excessive VSWR or high PA temperatures occur, the unit will display the associated front panel LED Indicators, and at the same time if set up - will also send any email alerts you may have set up. The front panel LED indicators for ALARM / VSWR / TEMP have the following status conditions:

- Green - Shown during normal operation.
- Yellow - Caution that the unit is experiencing a condition that could affect normal operation.
- Red - the unit is protecting itself under high VSWR conditions.



The front panel LEDs provide a quick and efficient insight into unit's status and condition. Some LED colours may have different meaning that are dependent on the configuration of the Transmitter.

Status LEDs

RF: Indicates status of the RF Transmitter

When RF is OFF, the LED is OFF	
When RF ON and loop in "Power Seek" mode, LED is	 Yellow
When RF ON and loop in "Power Locked" mode, LED is	 Green
When RF ON and fault is indicated "Zero RF Power", LED is	 Red
When INTERLOCK/External RF MUTE is active, LED is	 Blue

VSWR: Indicates status of the RF reflected power and protection

When RF is OFF, the LED is OFF	
When RF is ON and VSWR is under 1.5, LED is GREEN	 Green
When RF is ON and VSWR is 1.5 and over, LED is	 Yellow
When RF is ON and VSWR fault is indicated "High Reflected RF Power" , LED is	 Red

TEMP: Indicates status of the RF Transmitter temperature and protection

When PA Temp is lower than Fallback Temperature, the LED is	 Green
When PA Temp is equal or higher than Fallback Temperature, the LED is	 Yellow
When "Over Temperature" fault is reported the LED is	 Red





ALARM/FAULT : Indicates overall health status of the unit

When a fault is reported the LED is	 Red
-------------------------------------	---





USER: User configurable indicator

This LED is user-definable in the User section of the Notifications menu

RDS: Indicates the source and level of the RDS signal

Source INTERNAL and RDS level >0%, the LED is	 Green
Source INTERNAL and RDS level =0%, the LED is	 Green
Source EXTERNAL, the LED is	 Yellow
RDS OFF, the LED is	 OFF

PILOT: Indicates the combined source info with Pilot level in MPX mode

MPX Source INTERNAL AND Stereo Mode STEREO Pilot level >0%, the LED is	 Green
MPX Source INTERNAL AND MONO mode OR Pilot level=0%, the LED is	 OFF
MPX Source External, the LED is	 Yellow
MPX Source Digital, the LED is	 Blue

The Inputs screen shows the current Audio Input settings, and also allows for these parameters to be adjusted to suit your requirement.

The Inputs screen shows the following parameters at a glance.

- ~ Digital In Level
- ~ Digital R Trim
- ~ Analog In Level
- ~ Analog R Trim

Audio Inputs

Both Digital and Analogue Audio inputs are available in the Cobalt Transmitter. Both types of inputs have exactly the same parameters available.

Digital In Level / Analogue In Level

The digital In Level setting ranges from -20dBFS to 0dBFS. The Analogue range is from 0dBu to 24dBu. The step size of both is 0.1dB.

Digital/Analogue Right Trim

This allows you adjust the gain of just one channel of the incoming audio signal. The trim range is +/-0.5dB. The step size should is 0.001dB.

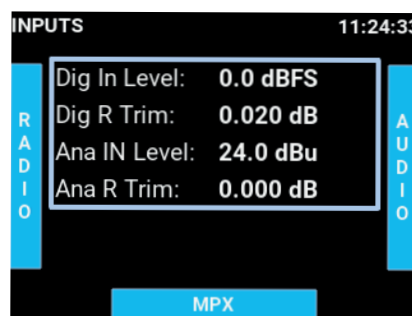

MPX Inputs

The Cobalt has two analogue and one digital MPX inputs. The two analogue MPX Inputs are on BNC Connectors. Input 1 one is dedicated as an Analogue MPX input. Input 2 is for RDS (SCA or AUX)

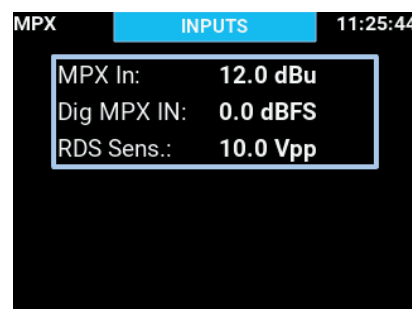

MPX In Level

The range is 0dBu to 12dBu and step size 0.1dB.

Digital MPX IN

Is used on the combined RJ45 connector in Studio HUB+ standard with digital audio. The range is -20dBFS to 0dBFS with 0.1dB step size.

RDS Sensitivity

Let's you adjust for low externally generated RDS signal level coming into the Cobalt.. The range is from 0.1 to 10Vpp with a step size of 0.1Vpp.

The built-in audio processor has 21 presets to choose from, as well as a bypass mode. It allows the user to select an audio processing preset.

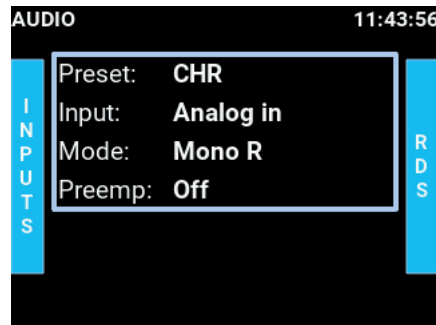

The Audio Processor screen shows the current settings at a glance.

- ~ **Preset** – selects the active audio processing preset
- ~ **Input** – selects the input to the audio processor (Analogue or Digital)
- ~ **Mode** – Channel mode (Stereo, Swap L/R, Mono L+R, Mono L, Mono R)
- ~ **Pre-emphasis** - selects the pre-emphasis setting (OFF, 50us, 75us)

The Audio Processor Presets

The Cobalt Audio Processor presets cannot be adjusted but they are set up and ready to use.

When selecting a preset, always try them with your program music and experiment with different ones as sometimes the name can be misleading based upon your genre. For example, metal music might be derived from rock but won't especially benefit from the rock'n'roll preset. Try CHR, tight or loud instead and you might feel they adjust better. When comparing some preset candidates, bear in mind that their effect in the programme sound won't be immediate due to the time constants in the audio processor. It is very important to use music that you know well to be able to distinguish changes to the sound. If you are still in doubt, CHR works well in most situations.

The Bypass Preset

This preset is intended to be used during lab tests, but it could also be used if you have already processed audio and still want to use the internal stereo generator.

If this is the case, you need to make sure that the pre-emphasis is applied in the external audio processor and set to OFF in the COBALT audio processor.

For safety, the main clippers are still in the chain and working although to facilitate some tests, the main clippers can be defeated when the bypass preset is selected. If you know what you are doing, you can defeat them but it's not at all recommended.

COMPARE

**LISTEN TO THE PRESET
OVER TIME, AND CHECK
AGAIN TO MAKE SURE IT
MATCHES YOUR OUTPUT**

The following is the list of the available presets as well as a brief description of each, so you can try to choose the one that best suits your station format or personal preferences.

Bypass preset

This preset force gates the AGC's, setting them to unity gain. The limiter and clipper thresholds are raised, and drives are appropriately set so that the peak input and output to the processor match.

AC

Designed for adult contemporary formats primarily, but is also a general, all round preset that can work for many other formats.

bright

Brings the highs out but in moderation. Closer to the clean preset than to the original bright presets.

CHR

If your station requires a sizzling hot presence, bright, in-your-face and standing out of the crowd, this is the preset for you.

Classic/Jazz

A very transparent, high fidelity preset for classical and jazz music, aimed to stay away from affecting the micro dynamics of the music, while providing overall levelling for enjoyable listening.

clean

A preset perfect for music where loudness is not everything. Easy on the clippers to control distortion and reduce listening fatigue. Try acoustic guitar, piano, pop and any easy listening and mellow music.

country

As the name implies, it is targeted to glide across modern and older country music formats (as well as other types of folk music) and bring those guitars, fiddles, and banjos to life.

golden

Designed to bring the best out of those classic tracks that never wear out and shine them back on the dial. From the 60s to 80s, this preset takes advantage of music produced before the digital era.

hot

A nice balance between bass and highs. Competitive but not as aggressive as CHR

indie

From Arctic Monkeys to Franz Ferdinand, but also The Killers and Coldplay... Indie, alternative rock and pop rock music formats should definitely try this preset.

Latin

Created brand new to address the complexity and uniqueness of such a wide and important music genre. Works great with various styles of salsa, mambo, cumbia, bachata, merengue, chan chan and, of course, cha cha cha.

loud

We aimed to create that larger-than-life sound with this preset: loud, yet with sufficient depth and impact, created to push the envelope!

low bass

Heavy on the bass, good for techno.

modern

Music such as reggaeton, modern hip-hop and trap brought style to how music is produced and mastered, and this preset was designed to keep that characteristic sharpness and edginess, rather than squash it down.

original bright

The original bright preset. Much brighter than F9. Try it with trance or dance with vocals.

original bright 2

An alternative to the original bright preset.

rock 'n' roll

For classic rock'n'roll, blues and similar styles.

smooth

Like the clean preset but with a bit more bass.

sports

Clarity of voice, intelligibility, keeping tabs on shouting announcers and keeping your audience right in the centre of that playing field or an important news – that's what this preset does. It can also work on news and talk formats, as an alternative to the existing talk preset.

talk

Optimised for talk radio and intelligibility. Works well for all talk-based formats.

tight

This preset uses some clipping on the bass and lots of limiting in the high end. Extreme metal music might benefit from this presets' tight sound.

urban

It has a fat bass sound but keeps the voice very present. Old school hip hop and RnB are natural choices.

The RDS screen allows you to adjust the basic RDS parameters for static operation from the front panel. The internal RDS encoder full feature set can be accessed via the web remote, including UECP compliant parameters for dynamic RDS.

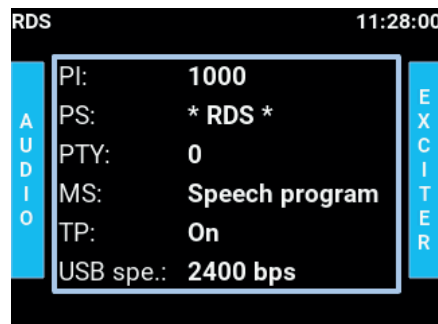

PI (Program Identifier):

This is a 4-digit hexadecimal number (0-9, then A-F) which is unique to your station normally assigned to you by your local Broadcast regulator or licensing body. It will consist of numbers, an example would be 6C3D.

PS (programme service name):

PS is one of the obligatory settings in RDS. This is the text that will display on a compatible RDS enabled Tuner. It consists of up to 8 characters (spaces are included as a character)

PTY (programme type):

This determines pre-defined programme types (e.g., PTY1 News, PTY6 Drama, PTY11 Rock music) and allows users to find similar programming by genre.

M/S (Music/Speech):

Music/Speech is used to identify if music or speech program is transmitted. The signal supports tuner with two individual volume modes one for music, the other for speech.

TA (Traffic Announcement):

The Traffic Announcement Flag is used to indicate an ongoing traffic announcement. A tune can use the TA flag to Auto-switch to FM tuner if another audio source is selected (CD, etc.) and to automatically adjust audio volume to increase the audio source during a traffic announcement.

USB Port Speed:

Set this according to your USB requirements, by default it's set at 9600 baud.



THE INTERNAL RDS ENCODER FULL SET OF FEATURES IS ONLY ACCESSIBLE VIA THE WEB INTERFACE

The COBALT offers many possible signal sources and great flexibility in routing and combining them.

Exciter

The exciter menu selects the source and mix of the signals that will form the multiplex going to the FM exciter and the amount of modulation for the carrier.

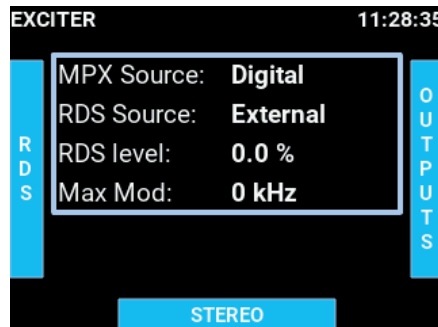

MPX Source

This selects the stereo encoded audio signal source and can be sourced externally (analogue or digital MPX inputs) or generated internally in the integrated stereo encoder.

RDS Source

All COBALT units include a very capable RDS encoder and, you can select by switching the RDS source to internal (remember to configure it in the right menu or in the web interface) If you want to use a third party RDS encoder, switch RDS source to external and don't forget to supply the transmitter's pilot to the external encoder to synchronise the RDS subcarrier. Side chain configuration is the only one recommended (otherwise a faulty RDS encoder would compromise the whole transmission). Switch RDS off if you don't want RDS or if the MPX is external and already includes the RDS with it.

RDS Level

This controls the amount of RDS in the full RDS mix and has a range of 0.0% to 6.0% in 0.1% steps. The Stereo Encoder part will be scaled accordingly so the combined signal doesn't exceed the selected 100% modulation limit. The stereo encoded signal amplitude will be scaled accordingly so the combined signal doesn't exceed the selected frequency deviation limit. For this to work properly with externally supplied RDS signals, remember to set the RDS input sensitivity to suit your RDS encoder output peak voltage in the inputs menu.

MAX Mod

This parameter controls the relationship between the MPX amplitude and the carrier's frequency deviation. In most countries, this should be 75kHz for a full amplitude MPX.

Stereo Encoder

Navigate down to Stereo from the Exciter screen to access these settings and be able to configure some of the internal stereo encoder settings.

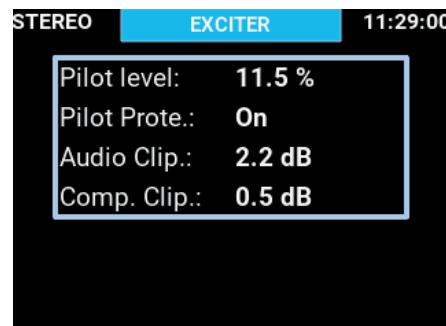

Pilot Level

This sets the level of 19kHz pilot tone, which is required for stereo synchronization. The range is 0 to 12% with 0.1% steps.

Pilot Protection

Enables or disables a notch filter in the MPX signal for clean pilot insertion. Excessive amount of MPX clipping can cause noise floor elevation or presence of distortion components close to the pilot tone. This can cause loss of stereo reception. The protection filter clears the pilot frequency band before 19kHz tone insertion. Options are ON or OFF.

Clippers

Clipping is a very effective method of increasing the perceived loudness while keeping a controlled peak level and it won't produce any audible side effects if performed in moderation. Excessive clipping, however, will produce a form of distortion that is unpleasant to hear.

Our clippers have mechanisms in place to keep the distortion at bay but the trade-off is that some peaks may go through. This will depend on the selected preset and programme material.

Whilst the clippers configuration is preset dependent, we have exposed the most important controls to the user:

Audio clipper

Controls the audio clippers' drive from -6 to 6 dB. As you increase the drive you will obtain more loudness, at the expense of distortion.

Composite clipper

Composite clippers drive. These clippers act on the stereo encoded audio and its effect is very noticeable so the range is limited to -0.5 to 2dB. We recommend to use the audio clippers over the composite ones to generate the required amount of loudness, because composite clipping introduces stereo crosstalk.



WARNING

Depending on the music content, clipper drives over 0dB might increase the number of peaks over the modulation limit. A few occurrences is fine but if you are worried you can either turn the drive down a bit or play with the frequency deviation.

The outputs screen shows parameters for the relevant output configuration of the Cobalt Transmitter. This menu has two pages, Outputs and MPX.

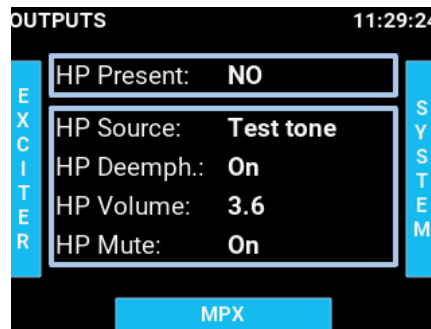

Outputs

On the outputs page, you will first see the Headphone (HP) status.

HP Source

This selects between the source for the Headphones output. By default, this is set to Processor. The other options are Analogue or Digital audio.

De-emphasis

This allows you to apply de-emphasis to the selected audio signal in case the audio signal to be monitored is pre-emphasized (from external audio processor for example). The parameters can be set to ON or OFF.

Headphone Volume

Adjust this to the desired Headphone output volume.

Headphone Mute

This will mute all output audio to the headphones and will override any set headphone volume level.

MPX outputs

Navigate down to MPX to access these settings. There are two physical analogue MPX outputs on Cobalt Transmitters. The output 1 has access to many MPX signals the output 2 is dedicated to the internally generated pilot, necessary for external RDS generation.

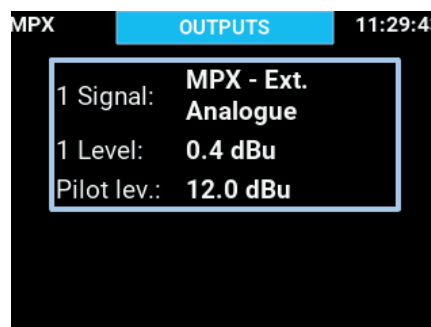

MPX Out Signal

This will set the source for MPX output 1.

MPX Out Level

This sets the output signal level for MPX output 1 in dBu. The range is 0-12dBu with 0.1dB steps.

Pilot Out Level

This sets the output signal level for MPX output 2 in dBu. The range is 0-12dBu with 0.1dB steps.

The System screen shows parameters for the various settings relating to the Cobalt Transmitter. This menu has 2 pages, System, and Network.

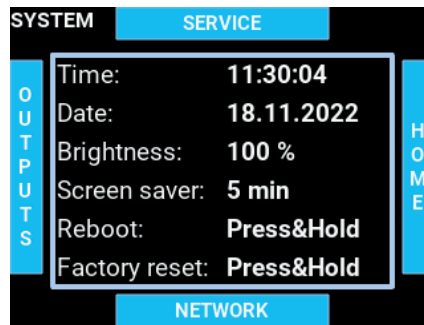

System

On the System page, you will first see the following useful information.

Time

This adjusts the manual Time setting.

Date

This adjusts the manual Date setting.

Brightness

This adjusts the screen and LED meters brightness, to your own level.

Screensaver

The screen saver has the following options, OFF, 1min, 5min, 15min, 30min

Network

The Network screen provides basic network settings, and also shows the current settings at a glance.

DHCP

Set DHCP to ON /OFF

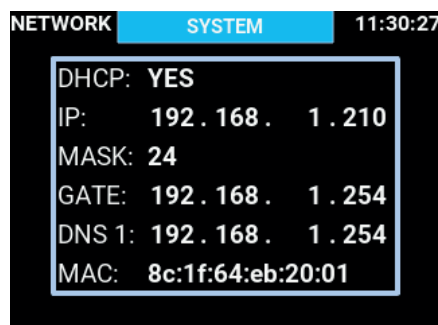

IP

Set your desired IP address here. Use the Joystick to navigate and to enter in the details.

Mask

Set the Mask here. Use the Joystick to navigate and to enter in the details.

Gateway

Set your Gateway here. Use the Joystick to navigate and to enter in the details.

DNS1

Set the DNS here. Use the Joystick to navigate and to enter in the details.

MAC

Set your MAC address here. Use the Joystick to navigate and to enter in the details.

All COBALT FM Transmitters feature a user-friendly Interface that is accessible from any web browser.

Please use the network screen on the front of the unit to determine or set the IP address and any other Network Parameters of the Cobalt Transmitter.

On any web browser, please enter the IP address of the unit, and press enter/search on the Browser bar.

You will then see the following screen, allowing you to enter in the default user credentials.



The screenshot shows the Aquabroadcast login page. At the top, the word "AQUABROADCAST" is displayed in a large, blue, sans-serif font. Below the logo, there are two input fields: "Username" and "Password". The "Username" field is a simple text box, while the "Password" field is a text box with a small eye icon on the right side to toggle visibility. Below the password field, there is a checkbox labeled "Remember me". At the bottom of the form, there is a prominent blue button with the text "Sign in" in white.

Please enter the username and password, and sign in.

LOGIN DETAILS

**THE DEFAULT USER LOGIN
CREDENTIALS FOR ALL COBALT FM
TRANSMITTER PRODUCTS IS**

USERNAME - admin

PASSWORD - pass

The main Dashboard is the default starting point of the Web Interface. From here , you can quickly see the most important information such as,

- ~ RF Status
- ~ Modulation
- ~ Frequency
- ~ Model
- ~ FWD Power
- ~ Serial Number
- ~ REV Power
- ~ Status
- ~ Temperature
- ~ Software Update

Unit Details

Model	Serial	Software	Unit Id	Unit time	Access	Alarm	Maintenance
C-10	1	1.7.3		13:46:46	REMOTE	OFF	Logs Update Reboot

RF

OFF

RF MUTE

Frequency

87.5 MHz

FSK OFF

FWD Power

0.0 w

SET 1.0 W

RFL Power

0.0 w

VSWR 0.0

PA Temp

34.4 °C

STATUS

PA Voltage: 0.0 V

PA Current: 0.0 A

FAN 1: 3569 RPM

FAN 2: N/A RPM

FAN 3: N/A RPM

Modulation 4.4 %

MPX Power -21.2 dBr

MPX Composition

Audio Level	Pilot	RDS	Total
97 % [73 kHz]	0 % [0 kHz]	3 % [2 kHz]	100 % [75 kHz]

RDS

PS	PI	PTY	TA	RT
RDS	FFFF	0	Off	

AUDIO PROCESSOR

INPUT: Analog in

PRESET: CHR

PRE EMPH: Off

STEREO

MODE: Mono L+R

ITU-R Limiter: On

ITU-R Threshold: 3.0 dBr

EXCITER

MPX: Internal

RDS: Internal

100% MOD: 75 kHz

SYNC

10Mhz in

1 PPS in

NETWORK

IP: 192.168.1.100

MAC: 8C:1F:64:EB:20:01

Local Button

On the front panel, there is a button labelled LOCAL. This feature allows the user to lock-out any remote user from changing any Transmitter parameters, when connected and accessed remotely. In local mode (Push the LOCAL button to enable this mode) it is possible to control the transmitter from the Front panel Joystick and buttons/display. In remote mode, this transfers full control of the COBALT Transmitter from the web remote.

The top right of the dashboard has an Icon showing any Alarm notifications, as well as language settings of the GUI, and the current user logged in to the unit.

CAUTION

Please ensure that after using the Front panel controls (LOCAL Mode), you press the button for one second to allow for full remote access to be available. If you do not do this you are not able to access the unit remotely, until you return to the site to enable the remote mode operation.

This screen gives the an overview of the current RF status and settings. Additionally you can also see the following information,

- VSWR Status
- PA Temp (stated in degrees Celcius)
- PA Voltage
- PA Current
- Fan Speed (Note, depending on the COBALT model, there may be several Fans installed. Not all models have all Fans installed).

These values can also be used if you suspect a faulty Fan or PSU failure.

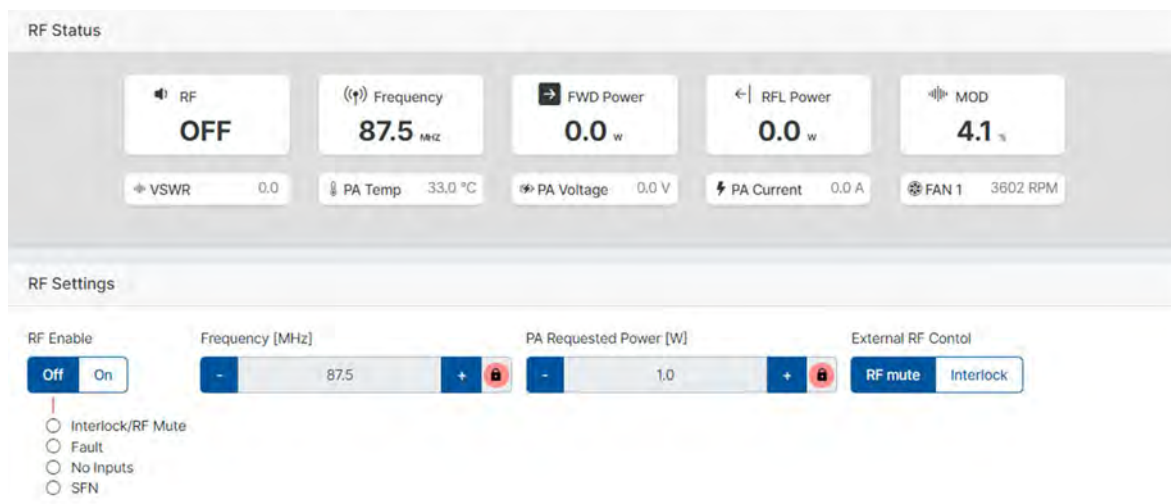

To adjust the Frequency, and PA requested Power, you need to click the **RED** padlock icon to unlock the editing mode, and then enter your desired value.

The lock stops you inadvertently making a change.

RF Enable

This lets you turn the RF power on or Off. The status indicators below the button show what is active when the RF is enabled ON.

External RF Control

Used on the external Pins, to allow either RF mute or Interlock when using an N+1 system.

FSK Settings

Used in some markets as a Station Identification method which is used in FM translator sites. The ID consists of consist of the call sign of the primary station followed by the letters “FM” and the number of the booster station being authorized, e.g., WFCCFM-1.

Adjust the settings to your regulator guidelines.

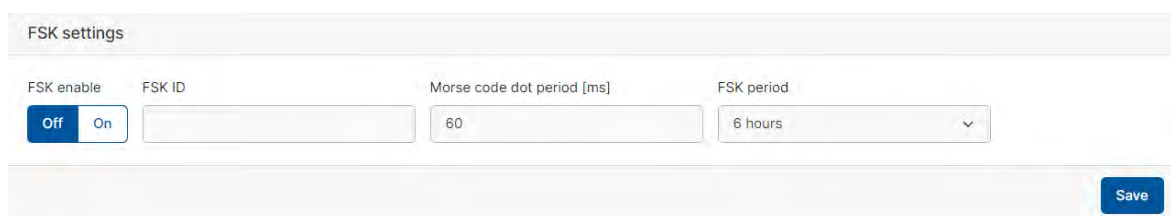

UMPX SCREEN

Available as an option on all COBALT Transmitters. μ MPX allows you to transmit your entire FM signal, including audio, RDS, and pilot tone, over a simple Ethernet cable at a Low bit rate (320 kbit/s).

YOU MUST ALREADY HAVE THE μ MPX ENCODER AT YOUR AUDIO SOURCE TO USE THIS FEATURE.

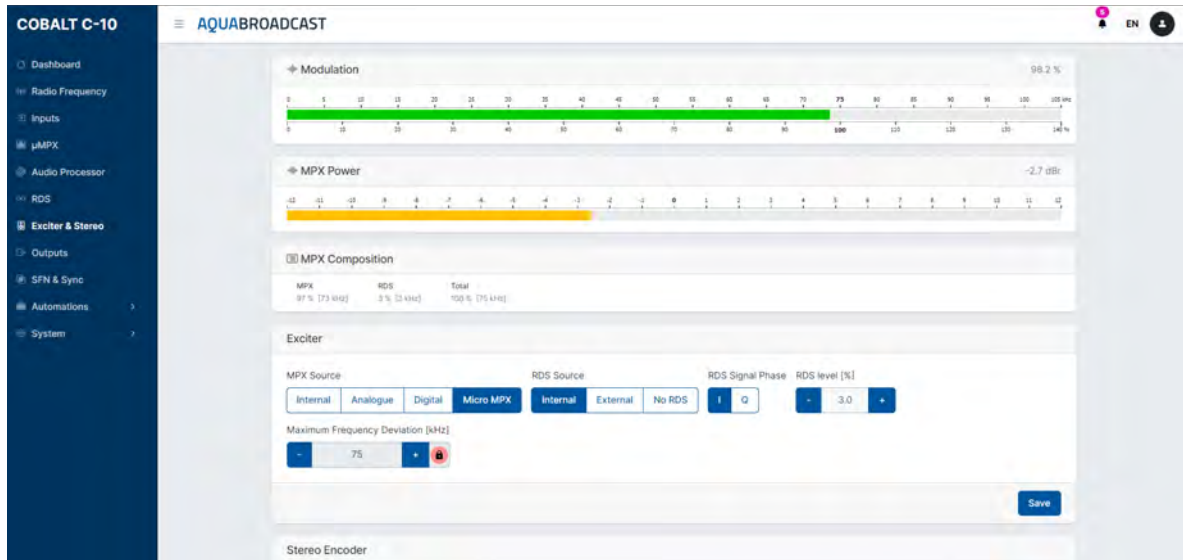

If you have this option enabled, the main menu will have the additional menu item for the μ MPX. If you don't see the μ MPX option on the left hand menu, then it is not installed and enabled.

The μ MPX sub-menu shows the Audio level when being received.

To use the service you need to enable it, as well as set your relevant Network port, and any delay and input level settings.

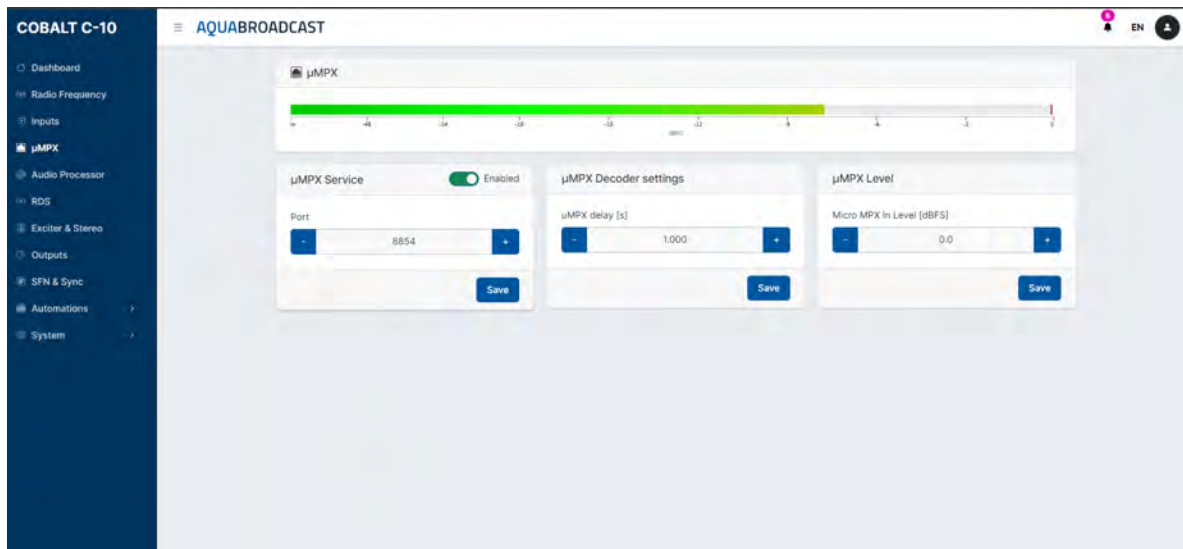

The μ MPX sub-menu shows the Audio level when being received.

To use the service you need to enable it, as well as set your relevant Network port, and any delay and input level settings.

Remember to save any setting changes for them to take effect.

INPUTS SCREEN

The COBALT allows you to use various inputs as your source.

Analogue Audio on XLR connectors

Dual MPX on BNC connectors

AES/EBU Digital Audio on RJ45 dongle (included)

You can easily adjust any of the required input levels and view live input metering from the active inputs.

The screenshot displays the 'Inputs' configuration screen for the COBALT device. At the top, there are five input type indicators: Digital Audio, Analogue Audio (selected), MPX, Digital MPX, and RDS. Below these are five live input meters showing signal levels in dBFS. The main configuration area is divided into sections for Digital Audio, Analogue Audio, and three MPX/RDS inputs. Each section contains level and trim controls, polarity options, and a 'Save' button.

Inputs

Digital Audio Analogue Audio MPX Digital MPX RDS

Digital Audio

Digital In Level [dBFS] Right Trim [dB] Digital In L Polarity Digital In R Polarity

- 0.0 + - 0.000 + Normal Invert Normal Invert

Save

Analogue Audio

Analogue In Level [dBu] Right Trim [dB] Analogue In L Polarity Analogue In R Polarity

- 0.0 + - 0.000 + Normal Invert Normal Invert

Save

MPX (MPX IN 1)

Ext MPX In Level [dBu]

- 12.0 +

Save

Digital MPX

Digital MPX In Level [dBFS]

- 0.0 +

Save

RDS (MPX IN 2)

Ext RDS Sensitivity [Vpp]

- 1.0 +

Save

Every Cobalt FM Transmitter ships with a 4-band Audio Processor as standard.

With 21 individually designed presets to choose from, you will be able to choose a setting that suits you right from the start.

If you choose the “bypass” preset, you can still utilize the excellent Exciter features of the Transmitter, while using any other external Audio Processor you choose.

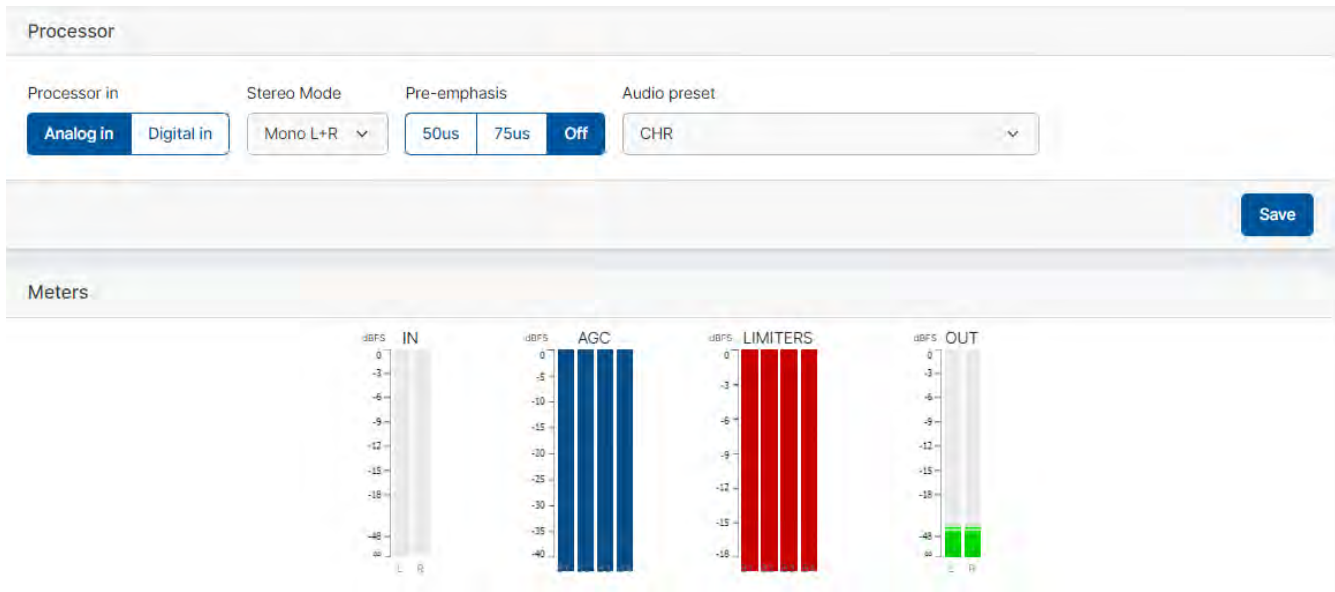

Select your Audio source, either Analog or Digital Audio input

Select your pre-emphasis (typically these are set to 75us in the USA, and 50us in Europe and many other countries)

The meters display the live audio and are low latency.

Always try the presets with your program music and experiment since sometimes the name can be misleading or not adapting well to some substyles. For example, metal music might be derived from rock but won't benefit at all from the rock'n'roll preset; instead try CHR, tight or loud.

When comparing some preset candidates, bear in mind that their effect in the sound won't be immediate due to the time constants in the audio processor. It is important to use music that you know well to be able to distinguish between changes in the sound due to production or to the audio processor. When possible, it is highly recommendable to assess the sound by listening to the received audio coming out from an MPX decoder or an FM receiver rather than from the unit's headphone output.

If you are still in doubt, CHR works well in most situations.

Please refer to pages 16 & 17 for the complete list of the presets along with some useful descriptions of each preset.

The Cobalt incorporates an RDS encoder as standard. This feature allows full dynamic control of all RDS parameters, such as PI, PS and RT (Program Identifier, Program Service –station name, and Radio Text)

The internal RDS encoders' full set of features is only accessible via the web remote. This also includes UECP compliant parameters. To set the basic RDS settings from the front of the unit, use the joystick to navigate to the relevant section, and click to enter and adjust the setting. Once the setting is set, click enter again to set, then move to the next parameter and enter any further information as required.

The "Activate" button activates the RDS parameters to be used for live RDS encoding, but it does not save them into non-volatile memory. So after a reboot or power cycle RDS values are populated from the EEPROM. "Save to EEPROM" should be clicked once you are happy with the RDS configuration. This saves the parameters into non-volatile memory. Then click Activate when all your RDS parameters are set and ready to go.

PI (Program Identifier)

This is a 4-digit hexadecimal number (0-9, then A-F) which is unique to your station normally assigned to you by your local Broadcast regulator or licensing body. It will consist of numbers, an example would be 6C3D.

PS (programme service name)

PS is one of the obligatory settings in RDS. This is the text that will display on a compatible RDS enabled Tuner. It consists of up to 8 characters (spaces are included as a character)

PTY (programme type)

This determines pre-defined programme types (e.g., PTY1 News, PTY6 Drama, PTY11 Rock music) and allows users to find similar programming by genre.

M/S (Music/Speech)

Music/Speech is used to identify if music or speech program is transmitted. The signal supports tuner with two individual volume modes one for music, the other for speech.

TA (Traffic Announcement)

The Traffic Announcement Flag is used to indicate an ongoing traffic announcement. A tune can use the TA flag to Auto-switch to FM tuner if another audio source is selected (CD, etc.) and to automatically adjust audio volume to increase the audio source during a traffic announcement.

Dynamic RDS

The Cobalt's RDS encoder can be used in static mode, by setting the above parameters at installation.

Alternatively, the unit's RDS settings can be controlled dynamically, receiving data input from an external source such as a play-out system or 3rd-party 'middleware' such as Magic RDS or RDS-Studio.

The RDS coder is UECP compliant (a standard protocol designed specifically to control RDS encoders) and can receive data via the LAN connection or UART USB port on the rear.

RDS Information

With RDS (RBDS in the US) , you can get listener's radios to display your station name or call-letters, up to 8 characters. This is what's entered in the 'PS' field. PS is one of the obligatory commands in RDS. One other is PI – an RDS encoder will not work without this.

PI means 'Program Identifier' and is a 4-digit hexadecimal number (0-9, then A-F) which is unique to your station certainly in your region if not in your country. This number is usually allocated by your country's regulatory authority, and will look something like 2E3F, for example. Please check with your regulator or look at you license paperwork to find out your unique PI code.

TP On

TP means 'this station sometimes broadcasts traffic information'. A lot of consumer car receivers will only stop a search on a station with this flag set ON. TA means 'this station is transmitting a traffic announcement now' and will cause radios to stop playing a CD and play the radio audio instead. Therefore, even if you don't carry traffic information, it's a good idea to have TP ON, but TA OFF unless you're carrying a traffic report right now.

MS Flag	MUSIC (speech if you're a talk-only station)
PTY	Select whichever is closest to your format
PTYN	Leave empty
RT	This is where the Now Playing information appears if that data is being sent to the RDS encoder, or you can just enter other station information.
AF	Alternate frequency – this is a list of frequencies your station is also broadcasting on. If you have more than one transmitter, select the number of transmitters here and then fill in their frequencies in the boxes. All your transmitters should carry the same AF list – or at least those frequencies in neighbouring areas. If you have just one transmitter, leave this at zero.

Once these basic entries are made, you're good to go – except for one thing: You need to set the RDS sub-carrier level. There is no real standard for this, but it's good to start at 3.5kHz which is 5% - so in the MPX section, set RDS Level to 5%.

Bear in mind that whatever percentage of RDS you use is deviation that you can't use for program audio – there is really no point in running more than 6% RDS level.

Note that if you are feeding dynamic data to the Cobalt's RDS encoder, the entries on the front panel and the web remote will not show this data but will continue to show the static data you've programmed in manually

This screen will at a glance give you a visual indication of the Modulation present.

Modulation 4.2 %

MPX Power -21.3 dB

Audio Level	Pilot	RDS	Total
97 % [73 kHz]	0 % [0 kHz]	3 % [2 kHz]	100 % [75 kHz]

Exciter

MPX Source: Internal, Analogue, Digital
 RDS Source: Internal, External, No RDS
 RDS Signal Phase: I, Q
 RDS level [%]: 3.0
 Maximum Frequency Deviation [kHz]: 75

Stereo Encoder

Pilot level [%] MONO: 9.0
 Pilot Protection: Off, On
 Audio level [%]: 100.0
 Audio level mode: Auto, Manual
 Clipper Drive [dB]: 2.2
 Composite Clipper Drive [dB]: 0.5
 Defeat clippers: Off, On
Available in Bypass Preset

MPX Power Limiter

ITU-R Limiter: Off, On
 ITU-R Threshold [dB]: 3.0

Exciter

On the Exciter section, you will see the following options;

MPX Source

This selects between the internally generated MPX (from the Stereo generator with processed audio with or without RDS), external analogue MPX input or external digital MPX input.

RDS Source

This sets between internal (built-in RDS) or external (for any third-party RDS encoder)

Max Frequency deviation

This is used to see the MPX signal level. In most countries, this should be at 100%=75kHz. (To adjust this please first click the Unlock icon and enter the value)

Stereo Encoder

The Stereo encoder comprises the MPX signal from audio channels, pilot and RDS signal. It automatically keeps the overall modulation within the 100% modulation limit.

Pilot level	Sets the level of 19kHz pilot tone, which is required for stereo synchronization. The range is 0 to 15% with 0.1% steps.
Pilot Protection	Enables or disables a notch filter in the MPX signal for clean pilot insertion. Excessive amount of MPX clipping can cause noise floor elevation or presence of distortion components close to the pilot tone. This can cause loss of stereo reception. The protection filter clears the pilot frequency band before 19kHz tone insertion. Options are ON or OFF.
ITU-R Limiter	Enables or disables the ITU-R limiter
ITU-R Threshold (dBr)	This adjusts the threshold and is adjustable from -6 to +12 dBr
Clipper Drive (dB)	This adjusts the threshold and is adjustable form -6 to +6dB

Clippers

Clipping is a very effective method of increasing the perceived loudness while keeping a controlled peak level and it won't produce any audible side effects if performed in moderation. Excessive clipping however, will produce a form of distortion that is unpleasant to hear. Our clippers have mechanisms in place to keep the distortion at bay, but the trade-off is that some peaks may go through. This will depend on the selected preset and programme material.

Whilst the clippers configuration is preset dependent, we have exposed the most important controls to the user.

Audio clipper

Controls the audio clippers' drive from -6 to 6 dB. As you increase the drive you will obtain more loudness, at the expense of distortion.

Composite clipper

Composite clippers drive. These clippers act on the stereo encoded audio and its effect is very noticeable so the range is limited to -0.5 to 2dB. We recommend to use the audio clippers over the composite ones to generate the required amount of loudness, because composite clipping introduces stereo crosstalk.

CAUTION

Depending on the music content, clipper drives over 0dB might increase the number of peaks over the modulation limit. A few occurrences are fine but if you are worried you can either turn the drive down a bit or play with the frequency deviation.

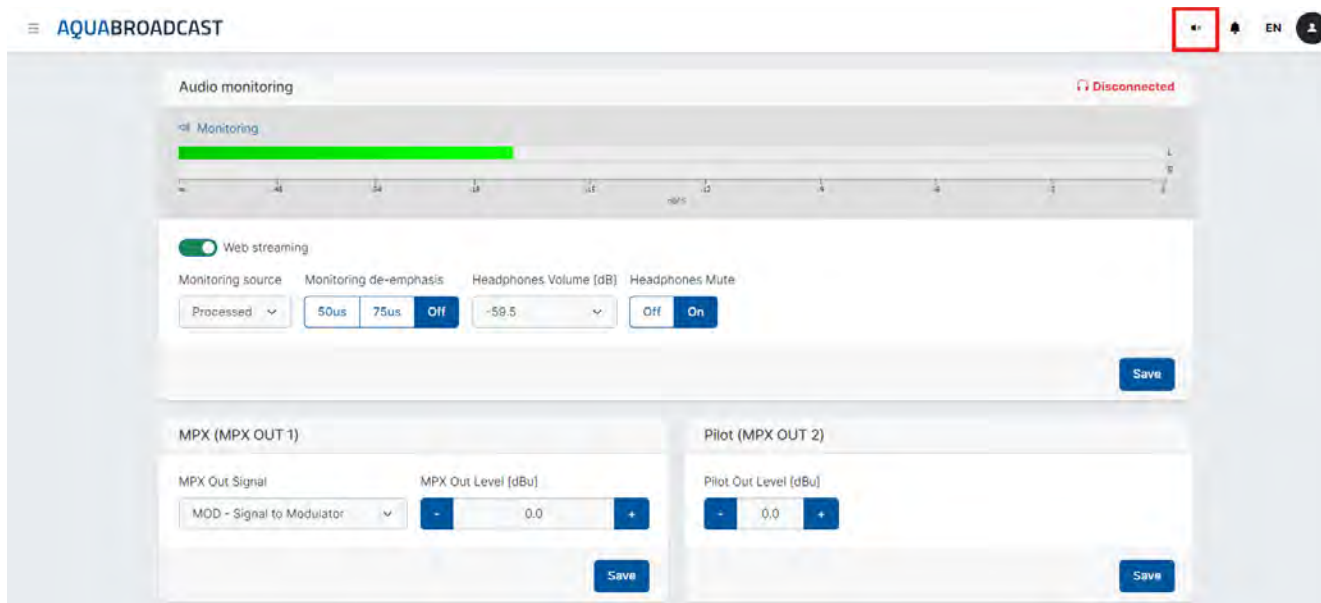

Audio Monitoring

All Cobalt models feature a built-in Audio monitor that can be used for confidence streaming purposes. Like the Headphones port on the front, you can choose to listen to the Analog audio, Digital Audio, Processed Audio, Audio Player, Test tone, or if you have the optional Tuner of MicroMPX installed, those too can be monitored. The Monitoring source selected will be applied to both the Headphone and web stream outputs.

The meter on this page shows the level of the monitored audio.

- Monitoring Source** This selects between the source for the Monitoring output. By default, this is set to Processor.
- Monitoring de-emphasis** This allows you to apply de-emphasis to the selected audio signal in case the audio signal to be monitored is pre-emphasized (from external audio processor for example).
- Headphone Volume** Adjust this to the desired Headphone output volume.
- Headphone Mute** This will mute all output audio to the headphones and will override any set headphone volume level.

To use the web streaming audio monitoring, you need to toggle the switch to the on position, select the monitoring source you want to use and then press SAVE. We recommend to keep it disabled when not in use.

You can then turn on or off the audio via the button near the top right of the page (Shown with a red border in the above picture).

MPX Outputs

Navigate down to MPX to access these settings. There are two physical analogue MPX outputs on Cobalt Transmitters. The output 1 has access to many MPX signals the output 2 is dedicated to the internally generated pilot, necessary for external RDS generation.

- MPX Out Signal** This will set the source for MPX output 1.
- MPX Out Level** This sets the output signal level for MPX output 1 in dBu. The range is 0-12dBu with 0.1dB steps.
- Pilot Out Level** This sets the output signal level for MPX output 2 in dBu. The range is 0-12dBu with 0.1dB steps.

The SFN (Single Frequency Network) screen lets you enter and adjust parameters to sync Cobalt Transmitters.

You will need to have an external GPS receiver that has both 10MHz and 1PPS sync outputs to connect to the appropriate BNC connectors on the back of the Cobalt. These need to be set to External on the SYNC Source when using the external GPS receiver.

A future option on Cobalt Transmitters will be an Internal GPS card which is an optional extra, in this case the settings should be set to internal.

The screenshot displays the SFN SYNC SCREEN interface, organized into several panels:

- SYNC Status:** Shows '10Mhz in' and '1 PPS in' with red indicator lights.
- Name:** Includes a 'Unit ID' input field and a 'Save' button.
- SYNC Source:** Features '10MHz source' and '1PPS source' with 'Internal' and 'External' toggle buttons, and a 'Save' button.
- Pilot SYNC:** Includes '1PPS Sync' (Off/On toggle) and 'Phase Offset [deg]' (0.0 with +/- controls), with a 'Save' button.
- Delay:** Contains 'Audio Delay [us]' and 'MPX Delay [us]' (both 0 with +/- controls), and a 'Save' button.
- Carrier SYNC:** Includes '1PPS Sync' (Off/On toggle), 'Phase Offset [deg]' (0 with +/- controls), and 'Modulation Disable' (Off/On toggle) with a 'For Testing Only' note, and a 'Save' button.

The Sync status lights will be **GREEN** when a valid sync from the GPS is obtained.

Ideally, its best to setup the sync using a suitable spectrum analyser, and to align the signals. You will still need to make some adjustments to the delay, and each system will need specific attention in getting the sync and delay correct. Field testing and listening will work hand in hand with any adjustments you make.

Please contact us for more information or any specific questions regarding the implementation or planning of your SFN Network.

The optional tuner module adds FM rebroadcast capability to the standard Cobalt FM transmitter functionality.

The high quality, digital tuner features DSP processing of receive signals, to ensure the highest quality reception, even during poor signal conditions. The tuner is highly sensitive and has excellent selectivity so it will also perform well on strong transmitter sites, where the receive and transmit frequencies are close together.

YOU MUST HAVE THE OPTIONAL TUNER INSTALLED TO USE THIS FEATURE.

If you have this option enabled, the main menu will have the additional menu item for the Tuner. If you dont see the Tuner option on the left hand menu, then it is not installed and enabled.

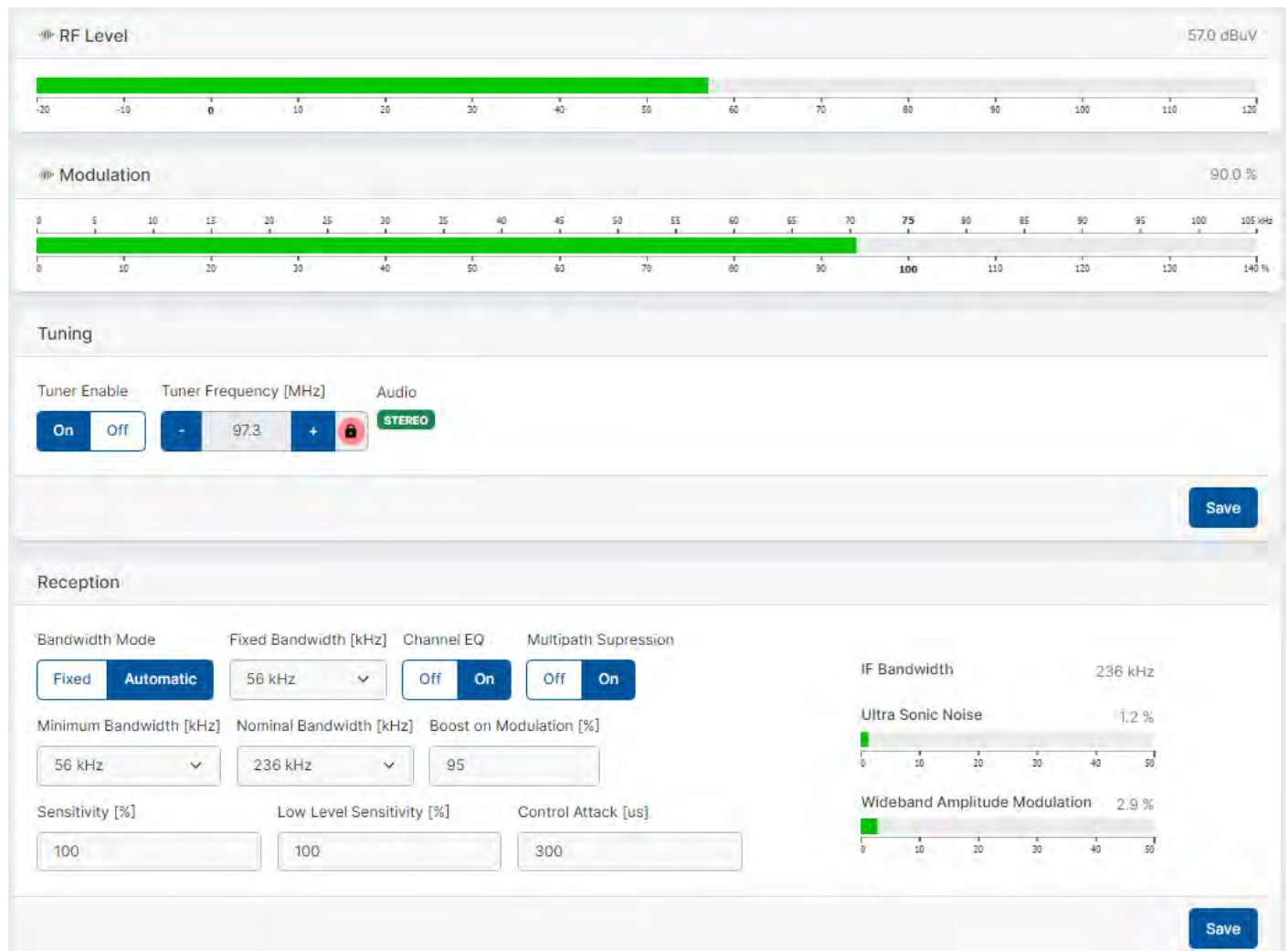

RF level

The tuner incorporates an AGC to adapt to varying reception conditions. This indicator shows the RF input signal level.

Modulation

It shows an approximate indication of the actual FM deviation as measured by the tuner.

Tuner Enable

Turn the tuner ON/OFF

Tuner Frequency

The range is 65.0 MHz to 108 MHz. The normal step size is 50 kHz. Press the RED unlock to adjust the frequency you need to receive. After setting the frequency, click Save

Audio

The presence of the pilot is checked to recognise stereo or Mono signals.

Bandwidth Mode

This parameter allows you to manually set the intermediate frequency filter bandwidth, or configure it to be automatically adjusted. To improve the field performance it is recommended to use the automatic IF bandwidth.

Fixed IF Bandwidth (KHz)

The IF bandwidth control can be explicitly set in a fixed position to any of the following values: 56 / 64 / 72 / 84 / 97 / 114 / 133 / 151 / 168 / 184 / 200 / 217 / 236 / 254 / 287 / 311 kHz. In the Automatic Bandwidth mode the IF filter bandwidth is controlled automatically. On normal conditions, the filter will use the nominal bandwidth but it will be closed if there are adjacent channels that could interfere. The specific conditions that trigger the bandwidth reduction and increase and how fast it will happen are controlled by several parameters, explained below.

Channel EQ

This setting provides the optional use of the FM channel equaliser. The advised setting is 'On' for improved field performance.

Multipath Suppression

This setting provides optional use of the FM multipath suppression system. The advised setting is 'On' for improved field performance.

Minimum Bandwidth (KHz)

Sets the minimum filter bandwidth. Please note that this restriction also applies in fixed bandwidth mode. Changing the minimum bandwidth default value will reduce the achievable adjacent channel suppression and changing the default value is not recommended but it might be considered for areas with 200kHz FM grid or higher.

Nominal bandwidth (KHz)

Sets the IF bandwidth employed during automatic control with healthy signals (good modulation index, no adjacent channel disturbance). Changing the nominal bandwidth may impair the modulation handling and the stereo channel separation performance so it should be used with care

Boost on Modulation (%)

For signals with large modulation deviation, the default bandwidth may be too small. This parameter controls the frequency deviation threshold that will trigger the opening of the filter.

Sensitivity (%)

In the automatic bandwidth mode the filter will be closed in the presence of adjacent channels to reduce the interference. This setting controls the sensitivity to adjacent channels, relative to the main channel.

Low level sensitivity (%)

This setting controls the sensitivity in low level signal reception as it may be wise to increase the sensitivity to adjacent channels in those conditions.

Control Attack (μ s)

Upon presence of adjacent channels the filter will be closed automatically. This setting controls the speed at which the filter will be closed, with smaller values being faster.

Audio

Tuner Audio In Level [dB] Deemphasis Stereo Enhancement Mono Enhancement

- 0.0 + 50us 75us Off High Blend FMSI Off On

Save

Tuner audio in level

This is the level that enters the Modulator and should be treated as any other Audio Input. Adjust as required.

Deemphasis

Select as per your local requirement, USA is 75 μ s, Europe and rest of the world is normally 50 μ s

Stereo Enhancement

High blend - The High blend setting has the left and right audio channels combined together to reduce noise, or hiss, which becomes common in stereo signals.

FMSI (FM Stereo Improvement) - uses DSP to eliminate the extra hiss often received on weak signals.

Mono Enhancement

Acts in a similar way to FMSI, but designed for MONO received signals.

Set to ON or OFF as required.

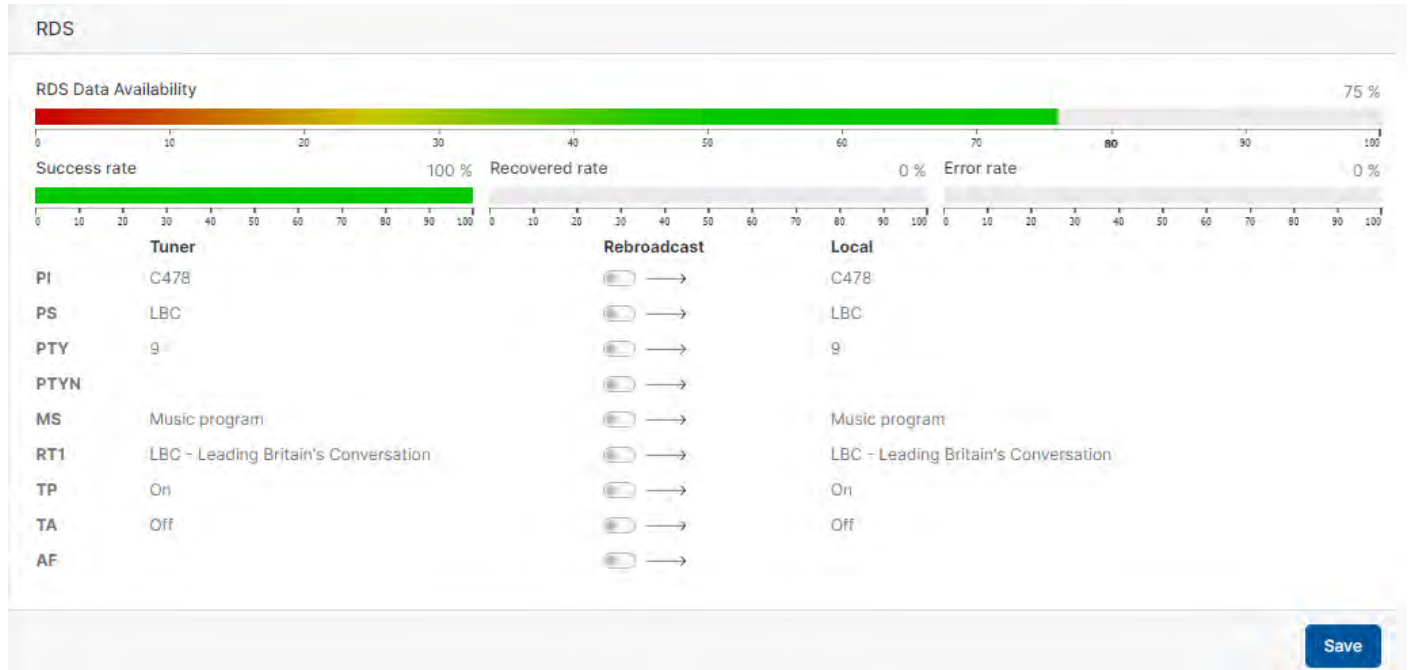

The meters above give a status view of the RDS signal being received by the tuner, if RDS is present on the received frequency.

RDS Data Availability

This shows the overall level and quality being received. As a guide 60% to 75% is normal.

Success rate

If any errors occur in the RDS Data, you will see a figure in % below 100%

Recovered rate

Errors in the RDS Data, that were re-coverable will be shown here.

Error rate

Errors in the RDS Data, that are totally lost are shown here.

Tuner RDS Data

Here you will see all RDS Data that is received by the Tuner

Rebroadcast

These buttons can be toggled to the ON position, see how to set this up in the next section.

The Tuner in the COBALT can be setup in several ways for various usage.

The tuner can also be listened to independently on either the Headphone Jack, or remotely if the Audio is streamed back.

You will need to set the Audio input level recieved by the Tuner, this is the level that enters the Modulator and should be treated as any other Audio Input.

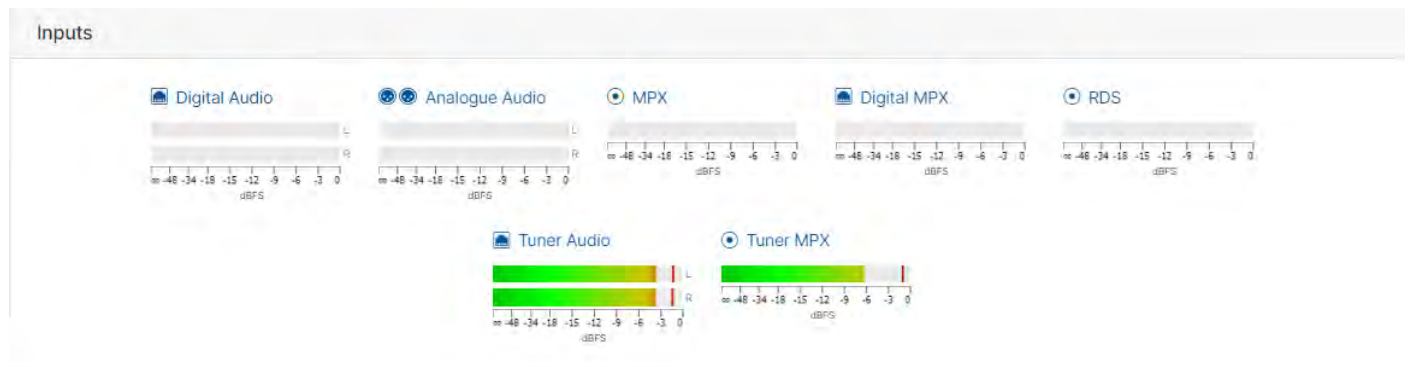

To use the Tuner as an Input, navigate to The Audio Processor menu. In the section "Processor In" select Tuner Audio In. Select your Stereo mode and pre-emphasis. Select the Bypass mode in the Audio Processor preset. You can of course choose a preset if you wish, but remember the recieved audio on the Tuner is likely to already be processed.

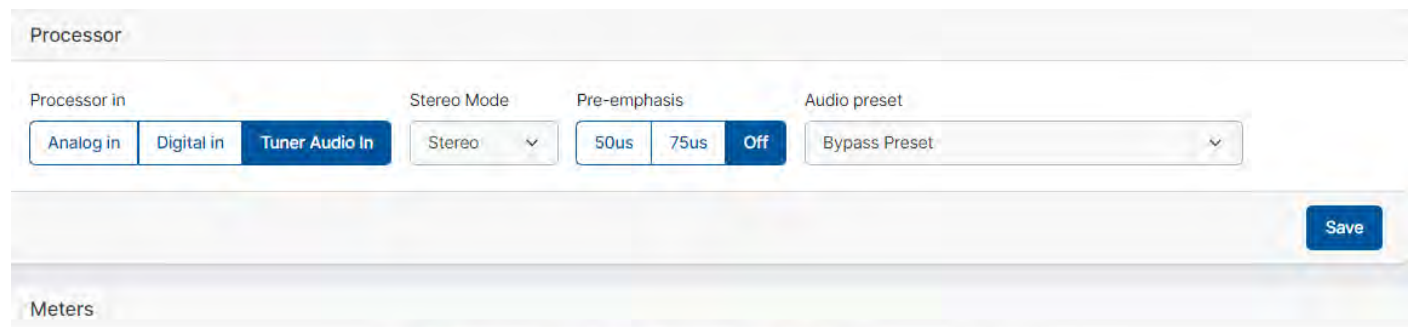

Now that you have set the audio input, its time to set the various parameters including Frequency as seen in the page before.

Now you need to decide how you will Transmit the RDS data. You have two options on doing this.

Option 1 - Generate local RDS Data in the COBALT

This is a useful function allowing full RDS and Stereo regeneration directly in the COBALT. Simply receive the audio from the Tuner and then setup your own local RDS to be transmitted.

Go to the Exciter and Stereo screen, and select Tuner MPX under the MPX source Tab. Then set RDS Source to Internal.

Go to the RDS menu and set your RDS parameters and click save.

Factory Defaults
Save to EEPROM
Port 1 speed
Clock Time and Date

Set to Factory Defaults
Save to EEPROM
2400
Off On

TCP server enable
TCP Port
Timeout [s]

- 5555 +
- 60 +

Save

RDS Data

Program identification
Program Service name
Program type number
Program type name enable
Program type name

1000
* RDS *
0
Enable Disable

Music speech
RT1
Traffic program
Traffic announcement

Speech program Music program

Off On
Off On

AF

AF 1
AF 2
AF 3
AF 4

AF 5
AF 6
AF 7
AF 8

Save

Go back to the Tuner menu.

You will see a section below called Rebroadcast with Toggleswitches next to each parameter. Make sure ALL the switches are set to OFF like in the image below.

RDS

RDS Data Availability

75 %

Success rate

100 %

Recovered rate

0 %

Error rate

0 %

	Tuner	Rebroadcast	Local
PI	C478	<input type="checkbox"/> →	C478
PS	LBC	<input type="checkbox"/> →	LBC
PTY	9	<input type="checkbox"/> →	9
PTYN		<input type="checkbox"/> →	
MS	Music program	<input type="checkbox"/> →	Music program
RT1	LBC - Leading Britain's Conversation	<input type="checkbox"/> →	LBC - Leading Britain's Conversation
TP	On	<input type="checkbox"/> →	On
TA	Off	<input type="checkbox"/> →	Off
AF		<input type="checkbox"/> →	

Save

Option 2 - Pass through RDS Data in the COBALT recieved from the Tuner

This function will allow all the RDS Data recived on the frequebncy by the Tuner to be passed through. You have the ability to select all or or only data you want to be transmitted to be passed through the modulator.

Go to the Exciter and Stereo screen, and select Tuner MPX under the MPX source Tab. Then set RDS Source to Internal.

Processor

Processor in: Analog in | Digital in | **Tuner Audio In**

Stereo Mode: Stereo

Pre-emphasis: 50us | 75us | **Off**

Audio preset: Bypass Preset

Save

Meters

dBFS IN (L, R)

dBFS AGC (B1, B2, B3, B4)

dBFS LIMITERS

dBFS OUT (L, R)

Go back to the Tuner menu.

You will see a section below called Rebroadcast with Toggleswitches next to each parameter. Make sure you set the switches are set to ON for any RDS Data you want to pass through and be transmitted. See the image below. The RDS data shown on the Tuner side and Loacl side will then match depening on which switch is activated.

RDS

RDS Data Availability: 76 %

Success rate: 100 %

Recovered rate: 0 %

Error rate: 0 %

	Tuner	Rebroadcast	Local
PI	C478	<input checked="" type="checkbox"/>	C478
PS	LBC	<input checked="" type="checkbox"/>	LBC
PTY	9	<input checked="" type="checkbox"/>	9
PTYN		<input checked="" type="checkbox"/>	
MS	Music program	<input checked="" type="checkbox"/>	Music program
RT1	On Air Now on LBC: Ben Kentish	<input checked="" type="checkbox"/>	On Air Now on LBC: Ben Kentish
TP	On	<input checked="" type="checkbox"/>	On
TA	Off	<input checked="" type="checkbox"/>	Off
AF		<input checked="" type="checkbox"/>	

Save

All COBALT products have a built-in Audio Player as standard.

The Audio Player can be used as a backup or a Primary Audio Source. You can either use a USB device connected to the USB port, or upload Audio files into the COBALT as Local storage. A Shoutcast/Icecast Stream with two inputs is also included. For the Audio manager to work, you must enable to "Enabled" toggle switch on the top right, and then click "Save"

Audio Manager Enabled

Local Inactive | USB Inactive | Stream 1 Monitoring https://audio-edg | Stream 2 Playing https://audio-edge-v

Audio Manager input: None | Local | USB | Stream 1 | **Stream 2**

Audio Manager output: None | **Web streaming**

Monitoring: Monitor Local, Monitor USB, Monitor Stream 1, Monitor Stream 2

Save

Audio Player settings Show ^

Stream

Stream 1 URL: https://audio-edge-vqwx4.yyz.g.radiomast.io/ref-lossless-ogg-flac-stereo

Stream 2 URL: https://audio-edge-vqwx4.yyz.g.radiomast.io/ref-lossless-ogg-flac-stereo

Save

Local Storage

Used: 0.08MB / 190.73MB

Choose Files | No file chosen

Clear local storage | **Upload**

Audio Player storage status Show ^

Local: rec-20250619-121101.mp3 | USB: «empty»

The Audio Player output lets you set if and how you want to monitor any of these via the remote listen stream function.

To use this, select the Web stream button, the toggle any or all of the audio player buttons to the right. You can then listen remotely to any of the Audio player modes that are available.

The Audio Player will only work when the enabled switch is toggled to on. You will then need to select which Player source you need.

Audio Player from Local Storage. (Maximum internal storage is 190MB)

Make sure the Audio Manager input is set to Local

Under Audio Player settings, click Choose files, and select the Audio Files from your Computer

Click Upload

Supported Formats

.mp3, .wav

Audio Player from USB

Make sure the Audio Manager input is set to USB

Insert the USB device / Cable into the Cobalt

Click Save

Supported Formats

.mp3, .wav

Supported USB Filesystems

ext4, FAT32, exFAT, NTFS



You can use the USB port as shown in the image for a USB memory stick or Hard drive.

Audio Player from Stream.

Select either Steam 1 or Stream 2 as the Audio source (Both can be used at the same time under different configs)

Enter the stream address into the Player Stream URL.

Click save

Supported Stream Formats

MP3, AAC-LC, HE-AAC v1, HE-AAC v2, Ogg Vorbis, Ogg Opus, Ogg FLAC

The Automations function in every COBALT Transmitter has been designed to be more powerful than anything else out there.

Unlike basic input source failovers that merely facilitate the switch between audio sources, we believe in providing a more comprehensive solution. Our system is meticulously designed to offer unparalleled flexibility in terms of routing inputs to the modulator, complemented by a robust failover mechanism.

This is achieved by changing transmitter configurations rather than simply changing the input source to the audio processor.

By changing the configuration instead of only the source means you can change not only the MPX and the RDS source but also the stereo generator configuration, audio preset and any other option available in the web interface.

Changing the transmitter configuration usually involves adjusting many settings.

For example, if the modulator source is an external MPX, changing to the internal MPX requires having the stereo generator and the RDS source already set up. This, in turn, requires the audio and RDS inputs (or the internal RDS generator) to be configured beforehand.

The configurations are there to help you set up the transmitter by altering the values of many parameters with the press of a button, which also prevents errors. These configurations can be utilized independently—either manually loading a configuration for a specific scenario or pre-loading them for seamless integration with automated processes.

Various scenarios can be effectively addressed using configurations. You have the option to save settings for individual sections in the web menu or save them all simultaneously.

Saving all sections proves beneficial when you need a backup of your default configuration, providing a point to revert to or allowing the fast setup of a replacement transmitter. This approach is particularly useful when deploying and configuring multiple Cobalt Transmitters is necessary, leaving the final site-specific configurations (system, network, etc.) to be completed later. Additionally, you may want to share a new configuration across your network.

Configurations become essential when Cobalt's are integral to a redundant system, ensuring that the backup transmitter rapidly replicates the configuration of the failed transmitter. In troubleshooting scenarios or when seeking support, configurations transform into invaluable tools.

On the other hand, if your objective is to address a specific situation (such as input source failure or loss of GPS sync) or to modify transmitter behaviour based on a schedule (e.g., audio preset, RF Power), you can easily do this.

Advice and Planning

The configurations act as if the user changed some parameters; this is they just recall a set of parameter values. We recommend you to follow some guidelines to use the configurations more efficiently:

PLAN AHEAD - Think of different scenarios and situations, what sections you need to change and consider if those sections depend on some other sections and you need to include them as well.

The best practice is to configure the transmitter and any other equipment for a given situation, test it thoroughly, and save it with a meaningful name related to the scenario or maybe the automation it is intended for.

ONLY SAVE THE SECTIONS YOU NEED TO CHANGE - If you want to have several automations operating at the same time without interfering with each other, it's best to limit the sections you include in a config.

Otherwise, there is a risk of inadvertently overwriting settings and encountering unpredictable behaviour.. For example, once you have all your input sources' levels adjusted, it's unlikely you want to change them, so probably you will leave this section out of most configurations.

MAKE A DEFAULT CONFIGURATION - It is very useful to have a default configuration to use as a starting point or as a backup which you can return to if you get lost or if the transmitter is left in a strange state.

Configs

To make a new Configuration is easy!

1. Setup all the required Transmitter settings you need, such as Frequency, Power, Input etc.
2. Click New.
3. Give it a name of your choice.
4. We advise adding a description, especially if you have multiple configs.
5. On the used sections, always select Audio processor and Exciter and Stereo. Then add any further sections you may need to use (the best practise is to only select the relevant options you need on each config)
6. Once you have selected all you need for the config, click SAVE

Repeat the process for each Config you may need

Actions

Activate

Save

New

Remove

Import

Export

Selected config

Aqua Broadcast Cobalt C-10 No mod

UUID: a1feb15e-3952-4c13-930e-094bd3cea2c2
Loss of Modulation

Primary Audio loss

UUID: d702b02f-ed6c-4ef2-a79a-feccd981c158
loss on Digital Input

Secondary Audio loss

UUID: 05857626-f919-40e9-98ef-111354868f6d
Loss on Analog Input

Parameters preview

(R) Radio Frequency	@ Audio Processor	@ Exciter & Stereo
RF Enable: On	Processor in: Digital in	MPX Source: Internal
Frequency: 87.5 MHz	Stereo Mode: Mono L+R	RDS Source: Internal
PA Requested Power: 1.0 W	Pre-emphasis: Off	Maximum Frequency Deviation: 75 kHz
External RF Control: RF mute	Preset: Bright	RDS level: 3.0 %
FSK enable: Off		RDS Signal Phase: I
FSK ID:		Pilot level: 9.0 %
Morse code dot period: 60 ms		Pilot Protection: On
FSK period: 6 hours		Clipper Drive: 2.0 dB
		Composite Clipper Drive: 1.0 dB
		Defeat clippers: Off
		ITU-R Limiter: On
		ITU-R Threshold: 3.0 dB

Name

Aqua Broadcast Cobalt C-10 No mod

Description

Loss of Modulation

Used sections

(R) Radio Frequency
 @ Inputs
 @ Audio Processor
 ∞ RDS
 @ Exciter & Stereo
 @ Outputs
 @ SFN & Sync

NOTE

EVERY FAILOVER CONFIG MUST HAVE AUDIO PROCESSOR AND EXCITER AND STEREO SELECTED. WITHOUT THESE THE CONFIG AND AUTOMATION WILL NOT WORK. ALL OTHER OPTIONS ARE RELEVANT TO THE CONFIG YOU DECIDE TO CONFIGURE

Modulation Failover

This facility lets you define a primary Audio source, as well as 3 additional backups. The meters at the top show all inputs that are live with either Audio, MPX, or RDS.

SETUP SOURCES

- Assign the required config here in the drop-down
- Activate this as the primary source, so the failover starts from the here.
- Toggle the enable switches for any other failovers you need, and again select the appropriate config from the drop-down list.
- On each Backup source, there is a configure menu. Here you can configure the threshold, delay, and reset delay (recovery), additionally you can also set the revert to primary on so that in the event the Main source is restored, this will take over in full again.
- Remember to click save on any changes you make, and make sure all are enabled for this to work.

At these early stages, we advise you to run some test to ensure that all works, by simulating issues such as unplugging audio sources etc.

Modulation Failover Enable

Digital Audio Analogue Audio MPX Digital MPX RDS

Source	Enable	Config	Modulation input
Primary Source	ACTIVE	Primary Audio loss	Digital Audio
Backup Source 1	Enable	Secondary Audio loss	Analogue Audio
Backup Source 2	Enable	No config	No Input
Backup Source 3	Enable	No config	No Input

AUTOMATION: INACTIVE Save

RF Off on Silence

If you lose all Audio sources, you will have "Dead Air". In this case you should turn off (Mute) the RF. The Cobalt lets you do this very easily.

HOW TO SET THIS UP

Go to the automations section labelled "RF Off" and set the minimum modulation % that should keep the RF on.

The default value should be fine in most cases. Make sure though that the set delay time is correct and certainly NOT SMALLER than the times used in the failover to avoid the RF being switched off before it should.

Remember to toggle the Enable button, and click save after you have set this up.

RF Loss on SFN

Additionally you can also set the RF Off when using an SFN.

This works in a similar way, but is tied to loss of signal on the rear BNC Connectors used for the 10MHz in and 1PPS inputs from a suitable external GPS receiver..

Remember to click save after you have set this up.

The screenshot displays the Cobalt automation configuration interface. At the top, the 'RF Off on Silence' section is active, with an 'Enable' toggle switch. Below this, a horizontal scale shows modulation percentage from 0 to 105. The 'Modulation < than threshold [%]' is set to 15. The 'Set delay [s]' and 'Reset delay [s]' are both set to 30. The 'RF Off Revert' toggle is turned on. A 'Reset' button is visible. Below this, the status shows 'DETECTOR: SILENCE' and 'AUTOMATION: INACTIVE'. A 'Save' button is located at the bottom right of this section.

The bottom section shows two sub-configurations: 'RF Off on 10MHz loss' and 'RF Off on 1PPS loss', both with 'Enable' toggles. The '10MHz in:' section has 'Set delay [s]' and 'Reset delay [s]' both set to 5. It includes 'RF Off' and 'RF Off Revert' toggle switches and a 'Reset' button. The '1PPS in:' section has identical settings for delay and toggle switches, also with a 'Reset' button.

Scheduler

You need to set up configurations first, in order to use the scheduler function.

The scheduler function allows you to create custom actions at set times and days to load a configuration that you setup. There are 9 schedules that you can set-up.

Each action must have its own schedule setup. If you want something to turn on at a time and date, you also need to set another schedule to revert it back to any other configuration you require.

Examples include, setting a specific power level at pre-determined times, changing an input for an alternative audio source.

The screenshot displays the 'Scheduler' configuration page. At the top right, there is a red 'Enable' toggle switch. Below this, four schedule entries are listed, each with the following components:

- #1:** Time: 00:00. Schedule on: Monday, Tuesday, Wednesday, Thursday, Friday, Saturday, Sunday (all unchecked). Config: No config. Buttons: Work days, Weekend, Copy, Paste, Reset.
- #2:** Time: 00:00. Schedule on: Monday, Tuesday, Wednesday, Thursday, Friday, Saturday, Sunday (all unchecked). Config: No config. Buttons: Work days, Weekend, Copy, Paste, Reset.
- #3:** Time: 00:00. Schedule on: Monday, Tuesday, Wednesday, Thursday, Friday, Saturday, Sunday (all unchecked). Config: No config. Buttons: Work days, Weekend, Copy, Paste, Reset.
- #4:** Time: 00:00. Schedule on: Monday, Tuesday, Wednesday, Thursday, Friday, Saturday, Sunday (all unchecked). Config: No config. Buttons: Work days, Weekend, Copy, Paste, Reset.

HOW TO SET THIS UP

Go to the automations section labelled "Scheduler"

For each schedule, you need to set the Time, days and configuration you want to load/activate. Each day can be individually turned on or off.

To set the time, simply click on the element and enter the time (24Hr format)

Schedule on

Select the days you require for the schedule to run, or use the two shortcuts below

Click Work Days - this will turn on all days Monday to Friday

Weekend - this will only turn on Saturday and Sunday

You can also copy the settings and then paste into another schedule for ease of use.

The top right enable is the switch to turn ON/OFF all schedules. This must be on to have any scheduled events active. Each of the 9 schedules needs to also be enabled ON/OFF for them to work.

Notifications

This section comprises of 5 parts.

At a glance you will be able to see any and all Notifications which may be associated with a Config setting.

HOW TO SET THIS UP

Go to the automations section labelled "Notifications"

For each of the 5 top sections, you need to set which variable you want to activate.

Faults

Be notified of various fault conditions by email or SNMP.

Find the relevant Fault you want to be notified of. Set email or SNMP (or both) to be notified accordingly if this fault occurs.

If the fault condition is resolved, and you want a notification of the fault no longer being active, toggle the "Send on revert" switch

The top right enable is the switch to turn ON/OFF all schedules. This must be on to have any scheduled events active. Each of the 9 schedules needs to also be enabled ON/OFF for them to work.

The screenshot displays the 'Notifications' configuration page. At the top right, there are buttons for 'Setup limit' and 'Clear notifications'. Below the title bar, there are navigation tabs for 'Fault', 'Alarm', 'GPI', 'Automation', and 'User'. The 'Fault' tab is selected and highlighted in red. The main content area lists six fault conditions, each with a 'Send on revert' toggle, 'Email' and 'SNMP Trap' notification options, and a 'NOT DETECTED' status indicator. The faults listed are: RF Fault, Critical VSWR, Fast VSWR Trip, Critical PA Temp, Fan Fault, and PSU Fault. At the bottom right, there is a 'Save Fault Changes' button.

Alarms

Critical Alarms can be notified by Email, SNMP Traps, and also entered into system Logs.

Find the relevant Alarm you want to be notified of. Set to write to the Log, send an email or SNMP (or all) to be notified accordingly if this fault occurs.

Select "Alarm LED" Toggle switch ON to show the LED lit on the front panel display.

Each Alarm notification required must have the "enable" toggle switch turned on

If the fault condition is resolved, and you want a notification of the fault no longer being active, toggle the "Send on revert" switch

The screenshot displays the 'Notifications' configuration page. At the top, there are tabs for 'Fault', 'Alarm', 'GPI', 'Automation', and 'User'. The 'Alarm' tab is selected. On the right side, there are buttons for 'Setup limit' and 'Clear notifications'. Below the tabs, there are seven alarm entries, each with its own configuration options and status indicator.

Alarm Name	Enable	Send on revert	Log	Email	SNMP Trap	Alarm LED	Status
VSWR Fallback	<input checked="" type="checkbox"/>	<input type="checkbox"/>	<input checked="" type="checkbox"/>	<input type="checkbox"/>	<input type="checkbox"/>	<input checked="" type="checkbox"/>	NOT DETECTED
Temp Fallback	<input checked="" type="checkbox"/>	<input type="checkbox"/>	<input checked="" type="checkbox"/>	<input type="checkbox"/>	<input type="checkbox"/>	<input checked="" type="checkbox"/>	NOT DETECTED
10MHz Loss	<input checked="" type="checkbox"/>	<input type="checkbox"/>	<input checked="" type="checkbox"/>	<input type="checkbox"/>	<input type="checkbox"/>	<input checked="" type="checkbox"/>	DETECTED
1PPS Loss	<input checked="" type="checkbox"/>	<input type="checkbox"/>	<input checked="" type="checkbox"/>	<input type="checkbox"/>	<input type="checkbox"/>	<input checked="" type="checkbox"/>	DETECTED
AC Power Loss	<input checked="" type="checkbox"/>	<input type="checkbox"/>	<input checked="" type="checkbox"/>	<input type="checkbox"/>	<input type="checkbox"/>	<input checked="" type="checkbox"/>	NOT DETECTED
DC Power Loss	<input checked="" type="checkbox"/>	<input type="checkbox"/>	<input checked="" type="checkbox"/>	<input type="checkbox"/>	<input type="checkbox"/>	<input checked="" type="checkbox"/>	DETECTED
Interlock/RF Mute	<input checked="" type="checkbox"/>	<input type="checkbox"/>	<input checked="" type="checkbox"/>	<input type="checkbox"/>	<input type="checkbox"/>	<input checked="" type="checkbox"/>	NOT DETECTED

At the bottom right of the page, there is a 'Save Alarm Changes' button.

GPI Setup

The GPI when Triggered, can notify you by Email, or SNMP Trap. The GPI pins are number relevantly to the actual available pins on the DB25 connector at the back of the unit.

Find the relevant GPI pin you want to be notified of triggering. Set to send an email or SNMP (or both) to be notified accordingly if this fault occurs. You also can Trigger an LED on the front Panel in either RED, GREEN, BLUE, or YELLOW as a visual indication of the event. These are on the LED labelled USER on the front panel.

Notifications
Setup limit
Clear notifications

Fault
Alarm
GPI
Automation
User

GPI 5	<input type="checkbox"/> Email <input type="checkbox"/> SNMP Trap	NOT DETECTED User Status LED <div style="display: flex; gap: 5px;"> none R G B Y </div>
GPI 6	<input type="checkbox"/> Email <input type="checkbox"/> SNMP Trap	NOT DETECTED User Status LED <div style="display: flex; gap: 5px;"> none R G B Y </div>
GPI 7	<input checked="" type="checkbox"/> Email <input checked="" type="checkbox"/> SNMP Trap	NOT DETECTED User Status LED <div style="display: flex; gap: 5px;"> none R G B Y </div>
GPI 8	<input type="checkbox"/> Email <input type="checkbox"/> SNMP Trap	NOT DETECTED User Status LED <div style="display: flex; gap: 5px;"> none R G B Y </div>
GPI 18	<input type="checkbox"/> Email <input type="checkbox"/> SNMP Trap	NOT DETECTED User Status LED <div style="display: flex; gap: 5px;"> none R G B Y </div>
GPI 19	<input type="checkbox"/> Email <input type="checkbox"/> SNMP Trap	NOT DETECTED User Status LED <div style="display: flex; gap: 5px;"> none R G B Y </div>
GPI 20	<input type="checkbox"/> Email <input type="checkbox"/> SNMP Trap	NOT DETECTED User Status LED <div style="display: flex; gap: 5px;"> none R G B Y </div>
GPI 21	<input type="checkbox"/> Email <input type="checkbox"/> SNMP Trap	NOT DETECTED User Status LED <div style="display: flex; gap: 5px;"> none R G B Y </div>

Save GPI Changes

GPO Setup

The GPO pins can be configured to pull High or Low. The GPI pins are number relevantly to the actually available pins on the connector at the back of the unit.

Analog Output Setup

The 4 available Pins can be individually turned on or off. Under the source, the following options are available;

Enable the required Pin

Select the source from the following options

- Always Low
- Always High
- FWD Power
- RFL Power
- PA Temp
- Modulation
- Frequency
- PA Voltage
- Fan Speed

Press save

GPO Setup

<div style="display: flex; justify-content: space-between; align-items: center;"> GPO 1 Active level </div> <div style="display: flex; justify-content: space-between; margin-top: 5px;"> Low High </div>	<div style="display: flex; justify-content: space-between; align-items: center;"> GPO 2 Active level </div> <div style="display: flex; justify-content: space-between; margin-top: 5px;"> Low High </div>	<div style="display: flex; justify-content: space-between; align-items: center;"> GPO 3 Active level </div> <div style="display: flex; justify-content: space-between; margin-top: 5px;"> Low High </div>	<div style="display: flex; justify-content: space-between; align-items: center;"> GPO 4 Active level </div> <div style="display: flex; justify-content: space-between; margin-top: 5px;"> Low High </div>
<div style="display: flex; justify-content: space-between; align-items: center;"> GPO 14 Active level </div> <div style="display: flex; justify-content: space-between; margin-top: 5px;"> Low High </div>	<div style="display: flex; justify-content: space-between; align-items: center;"> GPO 15 Active level </div> <div style="display: flex; justify-content: space-between; margin-top: 5px;"> Low High </div>	<div style="display: flex; justify-content: space-between; align-items: center;"> GPO 16 Active level </div> <div style="display: flex; justify-content: space-between; margin-top: 5px;"> Low High </div>	<div style="display: flex; justify-content: space-between; align-items: center;"> GPO 17 Active level </div> <div style="display: flex; justify-content: space-between; margin-top: 5px;"> Low High </div>

Save

Analog Out Setup

<div style="display: flex; justify-content: space-between; align-items: center;"> <div style="text-align: left;"> Analog Out 9 <input type="checkbox"/> Enable </div> <div style="text-align: right;"> Source <div style="border: 1px solid #ccc; padding: 2px; font-size: 0.8em;">Always Low</div> </div> </div>	<div style="display: flex; justify-content: space-between; align-items: center;"> <div style="text-align: left;"> Analog Out 10 <input type="checkbox"/> Enable </div> <div style="text-align: right;"> Source <div style="border: 1px solid #ccc; padding: 2px; font-size: 0.8em;">Always Low</div> </div> </div>
<div style="display: flex; justify-content: space-between; align-items: center;"> <div style="text-align: left;"> Analog Out 22 <input type="checkbox"/> Enable </div> <div style="text-align: right;"> Source <div style="border: 1px solid #ccc; padding: 2px; font-size: 0.8em;">Always Low</div> </div> </div>	<div style="display: flex; justify-content: space-between; align-items: center;"> <div style="text-align: left;"> Analog Out 23 <input type="checkbox"/> Enable </div> <div style="text-align: right;"> Source <div style="border: 1px solid #ccc; padding: 2px; font-size: 0.8em;">Always Low</div> </div> </div>

Save

Automations

When Triggered, can notify you by Email, or SNMP Trap. They also can Trigger an LED on the front Panel in either RED, GREEN, BLUE, or YELLOW as a visual indication of the event. These are on the LED labelled USER on the front panel. Enable "Send on revert" to allow notifications to be sent when the fault condition is cleared and no longer triggering an alert.

Notifications
Setup limit
Clear notifications

Fault
Alarm
GPI
Automation
User

Main Source not Present DETECTED

Enable Log

Send on revert Email

SNMP Trap

User Status LED: none R G B Y

Backup Source not Present NOT DETECTED

Enable Log

Send on revert Email

SNMP Trap

User Status LED: none R G B Y

Input Source Switched

Enable Log

Send on revert Email

SNMP Trap

User Status LED: none R G B Y

RF Muted on Silence NOT DETECTED

Enable Log

Send on revert Email

SNMP Trap

User Status LED: none R G B Y

RF Muted on Sync Loss NOT DETECTED

Enable Log

Send on revert Email

SNMP Trap

User Status LED: none R G B Y

Save Automation Changes

NOTE

AN ACTIVE CONFIGURATION WILL ALWAYS BE OVERRIDDEN BY ANOTHER CONFIG IF IT IS EITHER TRIGGERED OR ACTIVATED BY A SCHEDULED EVENT

User

These have similar functions to the others above, but can also be used to not only send Emails, and SNMP traps, but also to trigger a GPO. Each detector can be configured individually to allow for greater control. The GPO could be used in many ways, but some examples are for indicator warning lights, starting remote Audio players etc. Enable "Send on revert" to allow notifications to be sent when the fault condition is cleared and no longer triggering an alert.

Notifications
Setup limit
Clear notifications

Fault
Alarm
GPI
Automation
User

FWD Power
DETECTED

Enable
 Send on revert

GPO ⓘ

Log
 Email
 SNMP Trap

User Status LED

RFL Power
NOT DETECTED

Enable
 Send on revert

GPO ⓘ

Log
 Email
 SNMP Trap

User Status LED

Modulation
DETECTED

Enable
 Send on revert

GPO ⓘ

Log
 Email
 SNMP Trap

User Status LED

VSWR
DETECTED

Enable
 Send on revert

GPO ⓘ

Log
 Email
 SNMP Trap

User Status LED

PA Temp
NOT DETECTED

Enable
 Send on revert

GPO ⓘ

Log
 Email
 SNMP Trap

User Status LED

PA Fan
NOT DETECTED

Enable
 Send on revert

GPO ⓘ

Log
 Email
 SNMP Trap

User Status LED

Analog Audio
DETECTED

Enable
 Send on revert

GPO ⓘ

Log
 Email
 SNMP Trap

User Status LED

Digital Audio
DETECTED

Enable
 Send on revert

GPO ⓘ

Log
 Email
 SNMP Trap

User Status LED

The system screen has 7 sections.

Services

Here you can enable and set various additional services like SNMP, Telnet and RS232. After enabling and/or changing a parameter, please make sure you save each relevant section before proceeding to the next section.

HTTP <input checked="" type="checkbox"/> Enabled	SSH <input checked="" type="checkbox"/> Enabled
Port: 80	Port: 22
<input type="button" value="Save"/>	<input type="button" value="Save"/>
HTTPS <input checked="" type="checkbox"/> Enabled	
Port: 443	Certificate details: No info to show
Certificate: Choose file No file chosen	
Private key: Choose file No file chosen	
<input type="button" value="Save"/>	

RS232 & TELNET

The Cobalt COBALT RS232&Telnet application notes is located near the end of this user manual.

SNMP <input checked="" type="checkbox"/> Enabled			
Engine ID:			
Port: 161			
v1/v2c communities <input type="button" value="Add community"/>			
COMMUNITY: public	HOST: *	ACCESS: Read-only	<input type="button" value="Delete"/>
v3 users SNMPv3 users are managed in User Management			
Trap receivers <input type="button" value="Add trap receiver"/>			
TYPE	HOST	DETAILS	
No trap receiver configured			
<input type="button" value="Send test trap"/>			
<input type="button" value="Download MIB"/>	<input type="button" value="Save"/>		

Unit

Front Panel

Brightness - adjust the Front panel Display and LED brightness to your choosing.

Local mode timeout - set the delay you want the screensaver to come on when using the front panel controls.

Screensaver level - Choose what you want to enter into a screensaver mode

OFF - No screensaver is enabled

Display only - The OLED will turn off, but the meters and LED will still be shown.

Display & LED's - all will turn OFF.

Screensaver timeout - set how long you want the delay to enable screensaver to come on.

Date and Time

NTP For automatic time and date settings you can connect to an NTP time server. Select your timezone for the correct area you are in. You can also click "Fill browser values" to automatically fill in your timezone.

You can also override these settings if you have your own NTP server that you prefer to use. Just unlock the padlock on the NTP override section and enter your own server details, then press save.

The screenshot shows two panels of the unit's web interface. The 'Front Panel' panel on the left has four input fields: 'Brightness [%]' with a value of 80, 'Local mode timeout [min]' with a value of 5, 'Screensaver level' with a dropdown menu set to 'Display & LEDs', and 'Screensaver timeout [min]' with a value of 5. The 'Date and time' panel on the right has a green 'NTP synchronized' status indicator, a toggle for 'Use NTP to obtain current date and time' which is turned on, a 'Timezone' dropdown menu set to 'Europe/London', and an 'NTP server override' field with a lock icon. Both panels have 'Save' buttons at the bottom, and the 'Date and time' panel also has a 'Fill browser values' button.

Factory Reset

There are two ways to reset the unit back to factory setting.

Do Factory reset

Clicking this will restore the unit back to factory settings.

Do factory reset (keep network settings)

Clicking this will restore all values of the unit back to factory settings EXCEPT the network settings, so you can still access the unit even remotely.

The screenshot shows a 'Factory reset' section in the web interface. It contains a heading 'Factory reset' and a sub-heading 'Factory reset wipes all user configuration and brings the unit into a clean state.' Below this are two buttons: 'Do factory reset' and 'Do factory reset (keep network settings)'.

Lock Screen

The front panel can be locked out to eliminate unauthorised access. This is done using the joystick as a means of setting the lockout.

There are 6 values you need to set, and can be any combination of movements.

The example on the next page shows the combination of,

Enter, Left, Right, Up, Down, Enter

You can choose your own combination.

If you forget the combination, you can easily choose a new one in the web interface.

Once you have set the combination, remember to click "enable" and click Save.

Lock screen Enable

Save

Network

You can adjust these parameters to suit your own network requirements, this can also be done from the front panel controls.

Network setting

MAC address: 8c:1f:64:eb:20:01

DHCP

IP address: 192.168.1.100 Netmask prefix length: 24

Gateway: 192.168.1.1

DNS 1: 192.168.1.1 DNS 2: 1.1.1.1

Save

Emails

Setup your Email notifications to recipients here. You can also choose secured methods (preferred) These emails will form the basis of any notifications on the unit that you may have chosen to use when setting up Automations and notifications.

SMTP

SMTP server address: SMTP server port: 25

Sender email: SMTP security: **Unsecured** StartTLS SSL/TLS

SMTP server username: SMTP server password:

Leave username and passwords fields empty if there is no authentication

Recipients:

Multiple recipients separated by comma

Send test email **Save**





User Management

You can setup multiple users on every Cobalt Transmitter. These can have different permission levels.

When setting up a User, please remember to set the Role and Password for each user.

Admin - set this for full control of the unit, with the ability to change any parameter.

Viewer - set this for limited control of the unit, restrictions will apply on certain parameters.

User Management				New user
USERNAME	FULL NAME	ROLE	SNMPV3	
admin	Admin	admin	—	 
viewer	Viewer	viewer	—	 

To setup , please click **New User**

Username - This may contain only lowercase characters, digits and '_' characters, no spaces can be used.

Fullname - set this to identify the user.

Role- Choose the type for this user.

Password - Choose your secure password

Edit user	
Username <input type="text" value="admin"/>	Full name <input type="text" value="Admin"/>
Role <input type="text" value="Admin"/>	
<input type="checkbox"/> Change password	
Password <input type="text"/>	Password again <input type="text"/>
<input type="checkbox"/> Allow SNMPv3	
Security level <input type="text" value="Authentication & Privacy"/>	Access <input type="text" value="Read-only"/>
Authentication algorithm <input type="text" value="SHA"/>	Authentication password <input type="text"/>
Privacy algorithm <input type="text" value="AES"/>	Privacy password <input type="text"/>

Allow SNMP

Here you can select if the user needs access to SNMP settings.

You must choose the Security level, as well as the access level, whether the user can only read, or read/write SNMP

Select your Authentication and privacy type and login credentials.

LOGS

System logs can be accessed from here. They are also accessible at all times from any page at the top right corner.

Each relevant log will be sorted by the most recent timestamp.

Clicking "SHOW" will open up further information showing the log including any errors.

You can also download the log and save to your Computer for further reference, archiving, or to share the log with our support department.

DATE	ACTIONS
13.12.2023	Show Download
08.12.2023	Show Download
07.12.2023	Show Download
29.11.2023	Show Download
28.11.2023	Show Download
17.11.2023	Show Download
28.09.2023	Show Download
27.09.2023	Show Download
18.09.2023	Show Download
17.09.2023	Show Download



NOTICE

The logs Timestamp will only be accurate when the Cobalt Transmitter is connected to a network with access to NTP Time servers on the Internet.

DIAGNOSTICS

The Diagnostics page gives you a quick and easy view of all relevant systems and statuses.

These are useful if you need to check systems locally or remotely.

System					
Front Panel MCU ✔ 0.7.0	PA/PSU MCU ✔ 0.2.12	FPGA ✔ 0.10	RF Clock ✔	RF DAC ✔	Audio Clock ✘
DSP ✔ 1.0.3	RDS ✔ Firmware v. 2.2d - ...	Network ✔	Headphones ✔	Aqua Glow ✔	
System Power					
Voltage INT 15.9 V	Voltage EXT 1.3 V	Current 0.9 A	Temperature 29.7°C		
RF and Amplifier					
FWD Power 0 W	REV Power 0 W	Frequency 98 MHz	Voltage 0 V	Current 0 A	Temperature 29.7°C
AC PSU1					
Installed ✘	MGM ✘	HWI ✘	Error ✔	AC Voltage N/A V	DC Voltage N/A V
Out Current N/A A	Temperature N/A°C	Status N/A			
AC PSU2					
Installed ✘	MGM ✘	HWI ✘	Error ✔	AC Voltage N/A V	DC Voltage N/A V
Out Current N/A A	Temperature N/A°C	Status N/A			
AC PSU3					
Installed ✘	MGM ✘	HWI ✘	Error ✔	AC Voltage N/A V	DC Voltage N/A V
Out Current N/A A	Temperature N/A°C	Status N/A			
Fan					
FAN1 3629 RPM	FAN2 N/A RPM	FAN3 N/A RPM			

 **NOTE**

SOME ITEMS MAY NOT SHOW IF THEY ARE NOT INSTALLED. AN EXAMPLE IS ON PSU, CERTAIN MODELS MAY HAVE ADDITIONAL PSU'S FITTED.

COBALT transmitters feature ASCII based access to several internal control and status parameters of the device either through telnet network or serial RS232 interface.

Physical Connection

For more details about the physical connections and pinout, please refer to the COBALT device relevant user manual chapter FRONT AND REAR IMAGES and PINOUTS. To avoid any communication malfunction, please use a standard communication cable recommended by the standard of appropriate communication type (ideally a shielded one).

Communication Settings

By default, TELNET and RS232 service is disabled. Please refer to the COBALT device relevant user manual chapter SYSTEM SCREEN for more information about the service activation and communication parameters settings.

Connection establish

Whatever terminal based PC software (e.g. Putty) is suitable for application connection. Before the connection establish all the communication parameters have to be set according the device Communication Settings. The terminal dialog is in text mode (ASCII).

Commands

List of available commands:

- help - print the list of available commands
- ping - return a "pong" if the connection is active
- paramlist - return the list of available parameters
- get - return the parameter value
get <parameter>
- set - write a
set <parameter> <value>
- quit - close the terminal connection

To indicate that the command processing was successful as well as value validity the system acknowledges with "OK" at the transfer end.

NAME	ACCESS	VALUES	COMMENT
unit.id	R/W	"xxxx"	Unit identification number
rf.enable	R/W	"on" or "off"	RF output enable/disable
rf.frequency	R/W	xxx.x ; e.g. <87.5;108>	RF frequency selection
rf.ext_control	R/W	"rf_mute" or "interlock"	
rf.rds.basic.af	R/W	"xxx.x.yyy.y...."	Alternative frequencies (list)
rf.rds.basic.ps	R/W	"xxxx"	Program service name
rf.rds.basic.pi	R/W	xxxx ; <4096-65535>	Program identification
rf.rds.basic.ta	R/W	"On", "Off"	Traffic announcement
rf.rds.basic.tp	R/W	"On", "Off"	Traffic program
rf.rds.basic.ms	R/W	"Speech program" "Music program"	Music speech
rf.rds.basic.ptly	R/W	xxx.x ; <0-31>	Program type number
rf.rds.basic.ptyn	R/W	"xxxx"	Program type name
rf.rds.basic.ptynen	R/W	"Enable", "Disable"	Program type name enable
rf.rds.basic.rt1	R/W	"xxxx"	Radio text 1
rf.rds.system.port_1_speed	R/W	xxxx ; <1200,2400,4800,9600,19200>	USB Port 1 Speed in [bps]
rf.rds.system.clock_time_date	R/W	"On", "Off"	Clock time and date
rf.rds.system.phase	R/W	"I" or "Q"	RDS signal phase
audio.preset	R/W	"xxxx" ; <01_bypass, 02_AC, 03_bright, 04_CHR, 05_class_jazz, 06_clean, 07_country, 08_golden, 09_hot, 10_indie, 11_latin, 12_loud, 13_low_bas, 14_modern, 5_orig_bright, 16_orig_bright_2, 17_rock_n_roll, 18_smooth, 19_sport, 20_talk, 21_tight, 22_urban>	Preset
audio.headphones.volume	R/W	xx.x ; <-59.5,-53.5,-50.0,-47.5,-45.5,-43.9,-41.4,-39.5,-36.5,-35.3,-33.3,-31.7,-30.4,-28.6,-27.1,-20.5,-19.6,-18.8,-17.8,-17.0,-16.2,-15.2,-14.5,-13.7,-13.0,-12.3,-11.6,-10.9,-10.3,-9.7,-9.0,-8.5,-7.8,-7.2,-6.7,-6.1,-5.6,-5.1,-4.5,-4.1,-3.6,-3.1,-2.6,-2.1,-1.7,-1.2,-0.8,-0.3,0.1,0.5,0.9,1.4,1.7,2.1,2.5,2.9,3.3,3.6,4.0>	Headphones volume [dB]

audio.headphones.mute	R/W	"On" or "Off"	Headphones mute
system.service.rds_tcp_server.port	R/W	xxxx ; x=[0..9]	RDS TCP server port
system.service.rds_tcp_server.enabled	R/W	"False", "True"	RDS TCP server Enable
system.service.rds_tcp_server.timeout	R/W	xxxx ; <1;86400>	RDS TCP server timeout [s]
system.local_access	R	"False", "True"	Local access
fp.brightness	R/W	xx ; <10;100> x10	Front panel brightness [%]
fp.screen_saver	R/W	xx ; <1;120>	Front panel screen saver timeout [min]
fp.screen_saver_level	R/W	"Off", "Display only", "Display & LEDs"	Screen saver mode
fpga.1pps_routing		"Internal", "External"	1pps signal source
fpga.10m_source	R/W	"Internal", "External"	10MHz clock source
dsp.meters.anainL.rms	R	xxx.xx	Analog input L rms level [dBFS]
dsp.meters.anainL.peak	R	xxx.xx	Analog input L peak level [dBFS]
dsp.meters.anainR.rms	R	xxx.xx	Analog input R rms level [dBFS]
dsp.meters.anainR.peak	R	xxx.xx	Analog input R peak level [dBFS]
dsp.meters.diginL.rms	R	xxx.xx	Digital input L rms level [dBFS]
dsp.meters.diginL.peak	R	xxx.xx	Digital input L peak level [dBFS]
dsp.meters.diginR.rms	R	xxx.xx	Digital input R rms level [dBFS]
dsp.meters.diginR.peak	R	xxx.xx	Digital input R peak level [dBFS]
dsp.meters.digMPXin.rms	R	xxx.xx	Digital MPX input rms level [dBFS]
dsp.meters.digMPXin.peak	R	xxx.xx	Digital MPX input peak level [dBFS]
dsp.meters.anaMPXin.rms	R	xxx.xx	Analog MPX input rms level [dBFS]
dsp.meters.anaMPXin.peak	R	xxx.xx	Analog MPX input peak level [dBFS]
dsp.meters.RDSin.rms	R	xxx.xx	RDS input rms level [dBFS]
dsp.meters.RDSin.peak	R	xxx.xx	RDS input peak level [dBFS]
dsp.meters.modulation.rms	R	xx.xx	RF modulation rms level [%]
dsp.meters.modulation.peak	R	xx.xx	RF modulation peak level [%]
dsp.params.processor_in	R/W	"Digital in", "Analog in"	Audio processor input selection
dsp.params.mpx_out1	R/W	"To FM mod", "To FM", "Internal MPX", "Ext MPX A", "Ext MPX D", "Internal RDS", "Ext. RDS", "Internal Pilot", "1kHz tone"	MPX OUT1 signal type selection
dsp.params.headphones_out	R/W	"Analog in", "Digital in", "Test tone", "Processed"	Headphones source signal
dsp.params.ana_in_level	R/W	xx ; <-10;24> x0.1	Analog in level [dBu]
dsp.params.ana_in_polarity_L	R/W	"Normal", "Invert"	Analog in L channel polarity
dsp.params.ana_in_polarity_R	R/W	"Normal", "Invert"	Analog in R channel polarity
dsp.params.ana_in_trim_r	R/W	x.xxx ; <-1;1> x0.001	Analog right channel trim level [dB]
dsp.params.dig_in_level	R/W	xx.x ; <-20;0> x0.1	Digital in level [dBFS]
dsp.params.dig_in_polarity_L	R/W	"Normal", "Invert"	Digital in L channel polarity
dsp.params.dig_in_polarity_R	R/W	"Normal", "Invert"	Digital in R channel polarity
dsp.params.dig_in_trim_r	R/W	x.xxx ; <-1;1> x0.001	Analog right channel trim level [dB]
dsp.params.ext_mpx_in_level	R/W	xx.x ; <0;12> x0.1	External MPX in level [dBu]
dsp.params.dig_mpx_in_level	R/W	xx.x ; <-20;0> x0.1	Digital MPX in level [dBFS]
dsp.params.ext_rds_in_sensitivity	R/W	xx.x ; <0.1;10> x0.1	External RDS sensitivity [Vpp]
dsp.params.exciter_mpx_gain	R/W	xxx.x ; <0;100> x0.1	Maximum frequency deviation [kHz]
dsp.params.mpx_out_level	R/W	xx.x ; <0;12> x0.1	MPX out level [dBu]
dsp.params.pilot_out_level	R/W	xx.x ; <0;12> x0.1	Pilot out level [dBu]
dsp.params.audio_delay_l	R/W	xxx ; <0;200000> x1	Audio delay [us]
dsp.params.mpx_delay	R/W	xxx ; <0;200000> x1	MPX delay [us]
dsp.params.mpx_source	R/W	"Internal", "Analogue", "Digital"	MPX source
dsp.params.dig_stereo_mode_selection	R/W	"Stereo", "Swap L/R", "Mono L+R", "Mono L" or "Mono R"	Digital stereo mode
dsp.params.dig_preemphasis	R/W	"Off" or "50us" or "75us"	Digital pre-emphasis
dsp.params.gps_1pps_sync	R/W	"On" or "Off"	GPS 1pps synchronization
dsp.params.pilot_phase_adjust	R/W	xxx.x ; <-180;180> x0.1	Pilot phase offset
dsp.params.mpx_pilotlevel	R/W	xxx ; <0;100> x1	Pilot level
dsp.params.mpx_pilotprotection	R/W	"On" or "Off"	Pilot protection
dsp.params.mpx_rdslevel	R/W	xxx ; <0;100> x1	RDS level
dsp.params.rds_source	R/W	"Internal", "External", "No RDS"	RDS source
dsp.params.clipper_drive	R/W	x.x ; <-6;6> x0.1	Clipper drive [dB]
dsp.params.mpx_clipperscompositedrive	R/W	xx ; <1;10> x1	Clipper distortion control
dsp.params.deemphasis_headphones_out	R/W	"Off" or "50us" or "75us"	Headphones de-emphasis
dsp.params.ITUR_onoff	R/W	"On" or "Off"	ITU-R limiter
dsp.params.ITUR_threshold	R/W	xx.x ; <-6;12> x0.1	ITU-R threshold [dB]
dsp.params.clippers_defeat	R/W	"On" or "Off"	Defeat clippers
psu.pa_requested_power	R/W	xxx.x ; (range according device manual)	RF output power
psu.fwd_power	R	xxx.x	RF output forward power
psu.rev_power	R	xxx.x	RF output reverse power
psu.vswr	R	xxx.x	RF VSWR coefficient
psu.fan_speed_measured_fan1	R	xxxx	FAN1 speed [RPM]
psu.pa_temperature	R	xxx.x	PA temperature [°C]
status.ext_1pps_detect	R	"False" or "True"	1pps external signal presence
status.ext_10mhz_detect	R	"False" or "True"	10MHz external signal presence
status.rf_interlock	R	"False" or "True"	Interlock status
status.indicator.rf	R	"0" – RF Off "R" – RF power is ON and fault is indicated "G" – RF is ON and set "O" – RF is ON and adjusting "B" – External RF MUTE is asserted	RF status
status.indicator.vswr	R	"0" – RF Off "R" – VSWR fault "O" – VSWR is >= Fallback VSWR value "G" – VSWR is < Fallback VSWR value	VSWR status
status.indicator.temp		"R" – "Over Temperature" fault is reported "O" – temperature is >= Fallback Temperature "G" – temperature is < Fallback Temperature	PA temperature status
product.serial_number	R	xxxx ; x=[0..9]	Product serial number
product.model	R	"C-xxxx" ; x= RF nominal power	
version.image	R	x.x.x ; x=[0..9]	Software version

COBALT C-2500

Output Power	2500
Range (W)	250-2500W
RF Output connector	7/8" EIA, 50 ohm
Input ACV @ 50/60Hz	208/400Vac Single or Three phases 47÷63 Hz
Power Connector	Phoenix
DC Input (optional)	48V DC
Power Supplies	3 (1 is for redundancy)
Dimensions WxDxH (inches)	19 x 24 x 3RU (7")
Dimensions WxDxH (cm)	48.3 x 60.0 x 17.8
Weight	28kg / 53lb

COBALT C-3000

Output Power	3000
Range (W)	30-3000W
RF Output connector	7/8" EIA, 50 ohm
Input ACV @ 50/60Hz	208/400Vac Single or Three phases 47÷63 Hz
Power Connector	Phoenix
DC Input (optional)	48V DC
Power Supplies	3 (1 is for redundancy)
Dimensions WxDxH (inches)	19 x 24 x 3RU (7")
Dimensions WxDxH (cm)	48.3 x 60.0 x 17.8
Weight	24kg / 62lb

COMMON SPECIFICATIONS ACROSS ALL COBALT MODELS

MODULATOR

Transmitter type	Solid-state FM Stereo transmitter
Modulator	Direct-to-channel (DDS)
RF Output Frequency Range	VHF Band II, (WORLDWIDE) 87-108MHz (USA) 88.1-107.9MHz
RF Frequency Steps	100kHz
Frequency Stability	±1 ppm or ±150Hz range with internal 10MHz clock reference
FM Modulation Range Capability	75kHz default, 100% modulation user adjustable up to 105kHz 140%, maximum 300kHz

RF

Power Stability	≤ ± 0.25dB
Asynchronous/AM noise	≤ -60dB
Synchronous AM s/n ratio	≤ -60dB
RF Harmonic and Spurious Suppression	Meets ETSI requirements
VSWR operation	Fully protected against gradual or sudden VSWR condition Proportional power reduction from VSWR 1.5:1

STEREO ENCODER

Performance	400Hz/1kHz test tones at modulation level ≤75kHz
Modes	Stereo, Mono L+R, Mono L, Mono R
Frequency response	20Hz-15kHz ±0.02dB
Pre-emphasis	0, 50 or 75µs
Pilot tone	19kHz, adjustable level 0-12%
Subcarriers suppression	≤ -70dB
Stereo separation	≥75dB AES/EBU input ≥70dB Analogue input
Stereo SNR	≥80dB with 75us de-emphasis ≥75dB without de-emphasis on both inputs
Stereo THD+N	<0.03%
Crosstalk	≥70dB, between L+R and L-R due to channel matching, both inputs

MONO PERFORMANCE

Frequency response	20Hz - 15kHz ±0.02dB
Pre-emphasis	0, 50 or 75 µs
Mono SNR	≥100dB, with 75us de-emphasis
Mono THD+N	≤0.002% analogue input, ≤0.001% AES input, with 75us de-emphasis

ANALOGUE AUDIO PERFORMANCE

Frequency response	10Hz-53kHz ±0.03dB
Pre-emphasis	53kHz-70kHz ±0.3dB
FM SNR	≥90dB, with 75us de-emphasis
THD+N	≤0.003% with 75us de-emphasis

DIGITAL MPX PERFORMANCE

Frequency response	0-90kHz ±0.005dB
FM SNR	≥100dB, with 75us de-emphasis
THD+N	≤0.001% with 75us de-emphasis

AUDIO INPUTS

Analogue	2 x XLR female, 10kΩ impedance level adjustable 0-24dBu
Digital	AES/EBU via RJ45 per StudioHUB+ Level adjustable -20 OdBFS sampling rates 32-192kHz

AUDIO OUTPUT

Headphones Out	1/4" (6.3mm) female stereo socket, software adjustable volume minimum load impedance 16Ω
----------------	--

WIDEBAND INPUTS

Analogue MPX	BNC, 10kΩ impedance, level adjustable 0-12dBu
Digital MPX	AES/EBU via RJ45 per StudioHUB+ level -20-0dBFS, sampling rate 192kHz left channel
Analogue RDS	BNC, 10kΩ impedance, level adjustable from 0.1-10Vpp

WIDEBAND OUTPUTS

Analogue MPX	BNC, 10Ω impedance, level adjustable 0-12dBu
Analogue Pilot	BNC, 10Ω impedance, level adjustable 0-12dBu

RDS GENERATOR

Type	Fully Dynamic RDS/RDS2/RBDS Generator
Protocol	ASCII commands, UECF protocol and X-Command Multi-port
Ports	UART over USB-B & Ethernet

WIDEBAND INPUTS

10MHz input	BNC, 50Ω terminated
1PPS input	BNC, 50Ω terminated
RF sample output	SMA, 50Ω, -30dBc
UART over USB	USB-B, system control
USB	2 x USB-A, storage & FW upgrade
Ethernet	1 x RJ45
RS232	DB25 shared connector, system control GPIO DB25 shared connector, 8 x output & 8 x input, all optically isolated DB25 shared connector, programmable
Interlock/ External RF Off	logic/polarity DB25 shared connector
Analogue voltage output	4-channel 0-5V range

TUNER (OPTIONAL)

Input	50 ohm BNC female
Tuning range	65-108MHz in 50kHz steps
Stereo Separation	> 50dB
Adjacent channel rejection (S+N)/N	74dB (Δf = 200kHz) mono: >69dB stereo > 60dB
AM suppression	>69dB

ENVIRONMENTAL

Altitude	15,000 ft / 4,420m AMSL
Temperature range	0 to +45°C working. -10 to +50°C storage
Humidity	95% @ 35°C, non-condensing

EU DECLARATION OF CONFORMITY

Aqua Broadcast Ltd declare under our sole responsibility that the radio equipment below,



Type: FM Transmitters

Models: Cobalt C-10, Cobalt C-30, Cobalt C-50, Cobalt C-100, Cobalt C-300, Cobalt C-600, Cobalt C-1000, Cobalt C-2500, Cobalt C-3000.

Intended use: Broadcast Transmitter

are in conformity with the essential requirements of the Directive 2014/53/EU (RED) and of the Directive 2011/65/EU (RoHS).

The models mentioned have been tested against the following standards or technical specifications:

1. Essential requirements for the protection of the health and safety of people, pets and goods, Article 3.1a) of Directive 2014/53/UE:
 - IEC/EN 60215(1998)+A1(1992)+A2(1994)
2. Essential requirements on electromagnetic compatibility levels, Article 3.1b) of Directive 2014/53/UE:
 - ETSI EN 301 489-53 V1.1.1 (2019-04)
 - ETSI EN 301 489-01 V2.2.3 (2019-11)
3. Essential requirements for the effective use of radio spectrum, Article 3.2 of Directive 2014/53/UE:
 - ETSI EN 302 018 V2.1.1 (2017-04)
4. Requirements in the Article 4 of Directive 2011/65/EU, towards the maximum tolerated concentrations of the substances listed in Annex II as modified by directive 2015/863/UE:
 - EN IEC 63000:2018

FCC CERTIFICATION

The following COBALT Models have been tested and independently certified by an approved FCC laboratory.



They have been passed and certified for FCC Part 73 use including LPFM applications.

Cobalt C-10

FCC IDENTIFIER: 2A9RR-COBALT10

FCC Rule Parts 73

Equipment Class:Licensed Broadcast Station Transmitter

Notes:Cobalt FM Transmitter

Cobalt C-30, Cobalt C-50, Cobalt C-100

FCC IDENTIFIER: 2A9RR-COBALT1U

FCC Rule Parts 73

Equipment Class:Licensed Broadcast Station Transmitter

Notes:Cobalt FM Transmitter

Cobalt C-300

FCC IDENTIFIER: 2A9RR-COBALT300

FCC Rule Parts 73

Equipment Class:Licensed Broadcast Station Transmitter

Notes:Cobalt FM Transmitter

Cobalt C-600, Cobalt C-1000

FCC IDENTIFIER: 2A9RR-COBALT2U

FCC Rule Parts 73

Equipment Class:Licensed Broadcast Station Transmitter

Notes:Cobalt FM Transmitter

If you need and advice or support, we are always on hand to help you as fast as we can.

We have various ways that you can contact us, and we always recommend any additional information is sent to us so we can quickly assist you.

Aqua Broadcast Limited

Unit 7, First Quarter

Blenheim Road

Epsom

KT19 9QN

United Kingdom

+44 203 411 0387

info@aquabroadcast.co.uk

Firmware updates

Please visit <https://www.aquabroadcast.co.uk/support> then simply click on the Downloads tab and select the latest firmware version available.

Alternatively, please scan the QR code below to link directly to the downloads section.



FIRMWARE

You will find the latest firmware version of your COBALT FM Transmitter on our website.

<https://www.aquabroadcast.co.uk/support>

